USER MANUAL

PAX2A – 1/8 DIN ANALOG

PANEL METER



SAFETY SUMMARY

All safety related regulations, local codes and instructions that appear in this literature or on equipment must be observed to ensure personal safety and to prevent damage to either the instrument or equipment connected to it. If equipment is used in a manner not specified by the manufacturer, the protection provided by the equipment may be impaired. Do not use this unit to directly command motors, valves, or other actuators not equipped with safeguards. To do so can be potentially harmful to persons or equipment in the event of a fault to the unit.

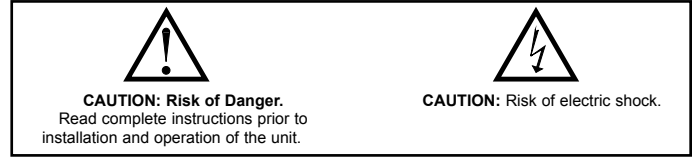

CE

C  **US LISTED**
3RSD
PROCESS CONTROL EQUIPMENT

TABLE OF CONTENTS

Ordering Information	4
Using This Manual	5
Crimson Programming Software	5
General Meter Specifications	6
Option Cards	8
1.0 Installing the Meter	9
2.0 Setting the Jumpers	9
3.0 Installing Option Cards	10
4.0 Wiring the Meter	10
5.0 Reviewing the Front Buttons and Display	12
PAX2A Display Loops	13
6.0 Programming The PAX2A	14
Module 1 - Input Setup Parameters (1-1 INPUT)	15
Module 2 - User Input/Function Key Parameters (2-FUNCTION)	16
Module 3 - Display Parameters (3-DISPLAY)	19
Module 4 - Secondary Function Parameters (4-SECONDARY)	21
Module 5 - Totalizer (Integrator) Parameters (5-TOTALIZER)	22
Module 6 - Setpoint Output Parameters (6-SETPOINT)	23
Module 7 - Serial Communications Parameters (7-SERIAL)	25
Serial Communications Overview	26
PAX2A Frequently Used Modbus Registers	27
Module 8 - Analog Output Parameters (8-ANALOG)	31
Module 9 - Factory Service Operations (9-FACTORY)	31
Troubleshooting	33
PAX2A Programming Quick Overview	35

ORDERING INFORMATION

Meter Part Numbers

MODEL NO.	DESCRIPTION	PART NUMBER
PAX2A	Universal DC Analog Input Panel Meter	PAX2A000

Option Card and Accessories Part Numbers

TYPE	MODEL NO.	DESCRIPTION	PART NUMBER
Option Cards	PAXCDS	Dual Setpoint Relay Output Card	PAXCDS10
		Quad Setpoint Relay Output Card	PAXCDS20
		Quad Setpoint Sinking Open Collector Output Card	PAXCDS30
		Quad Setpoint Sourcing Open Collector Output Card	PAXCDS40
		Dual Triac/Dual SSR Drive Digital Output Card	PAXCDS50
		Quad Form C Relay Digital Output Card	PAXCDS60 *
	PAXCDC ¹	RS485 Serial Communications Card with Terminal Block	PAXCDC10
		Extended RS485 Serial Communications Card with Dual RJ11 Connector	PAXCDC1C
		RS232 Serial Communications Card with Terminal Block	PAXCDC20
		Extended RS232 Serial Communications Card with 9 Pin D Connector	PAXCDC2C
		DeviceNet Communications Card	PAXCDC30
		Profibus-DP Communications Card	PAXCDC50
	PAXCDL	Analog Output Card	PAXCDL10
Accessories	CBLUSB	USB Programming Cable Type A-Mini B	CBLUSB01
	RCP	Replacement Case with knock-out features.	RCPX2H00

Notes:

¹ For Modbus communications use RS485 Communications Output Card and configure communication (TYPE) parameter for Modbus.

* This card is not suitable for use in older PAX2 models. For proper installation, 3 case knock-out features must be present on the top case surface. To update a case to include these knock-outs, a replacement case is available.

USING THIS MANUAL

This manual contains installation and programming instructions for the PAX2A and all applicable option cards. To make installing the option card easier, it is recommended to use the Installation Guide provided with the card.

Only the portions of this manual that apply to the application need to be read. Minimally, we recommend that General Specifications, Reviewing the Front Buttons and Display, and Crimson® Programming Software portions of this manual be read in their entirety.

We recommend that unit programming be performed using Crimson programming software. When using Crimson, the programming portion of this manual serves as an overview of the programming options that are available through Crimson. The programming section of the manual will serve to provide expanded explanations of some of the PAX2A programming features found in Crimson. For users who do not intend to use Crimson to program their unit, this

manual includes information to provide for a user to program one, or all, of the programming parameters using the unit's keypad.

To find information regarding a specific topic or mnemonic, it is recommended that the manual be viewed on a computer and the "find" function be used. The alternate method of finding information is to identify the programming parameter involved and review the information contained in the section of the manual that pertains to that parameter.

CRIMSON PROGRAMMING SOFTWARE

Crimson® software is a Windows® based program that allows configuration of the PAX® from a PC. Crimson offers standard drop-down menu commands, that make it easy to program the unit. The unit's program can then be saved in a PC file for future use.

PROGRAMMING USING CRIMSON:

Crimson is included on the Flash Drive that is shipped with the PAX2. Check for updates to Crimson at <http://www.redlion.net/crimson2>.

- Install Crimson. Follow the installation instructions provided by the source from which Crimson is being downloaded or installed.
- Using a USB Type A-Mini B cable, plug the Mini B end of the cable into the PAX2 USB Programming Port.
- Plug the other end of the USB cable into an available USB port on the PC.
- Apply power to the PAX2. See Troubleshooting, on page 33, for error message resolution.
- Start Crimson.
- Click the Crimson "Link" tab.
- Click "Extract..."
 - o Crimson will extract the current program settings from the PAX2.
 - o If the PAX2 has not been programmed, the extracted file will contain factory settings. Note that the PAX2 factory settings vary based on the option cards installed.
- A programming selection screen will appear. Double click on an applicable programming selection and make program specific parameter selections. When completed, click "Close" and continue selecting applicable programming selections and making appropriate parameter selections. Continue until all necessary programming parameters have been configured.
- When all programming selections have been made, save the configuration file.
- Download the configuration file to the PAX2 by clicking the "Link" tab and selecting "Update".

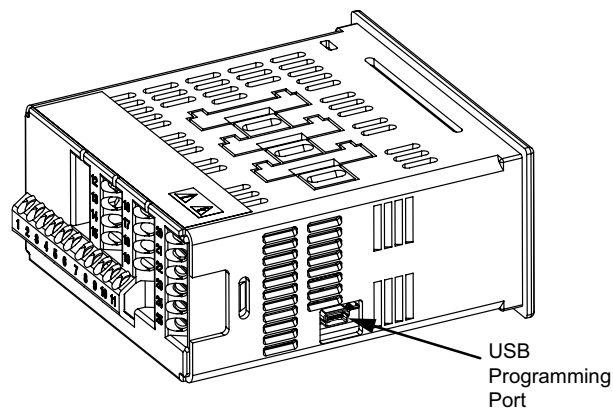

GENERAL METER SPECIFICATIONS

1. **DISPLAY:** Negative image LCD
 Top Line - 6 digit, 0.71" (18 mm), with tri-color backlight (red, green or orange), display range: -199999 to 999999;
 Bottom Line - 9 digit, 0.35" (8.9 mm), with green backlight, display range: -199,999,999 to 999,999,999

2. **POWER:**
 AC Power: 40 to 250 VAC, 50/60 Hz, 20 VA
 DC Power: 21.6 to 250 VDC, 8 W
 Isolation: 2300 Vrms for 1 min. to all inputs and outputs.

3. **ANNUNCIATORS:** Backlight color: Red
 1 - setpoint alarm 1
 2 - setpoint alarm 2
 3 - setpoint alarm 3
 4 - setpoint alarm 4
 Line 1 Units Display – programmable 3 digit units annunciator with tri-color backlight (red, green or orange)

4. **KEYPAD:** 2 programmable function keys, 4 keys total

5. **A/D CONVERTER:** 24 bit resolution

6. **UPDATE RATES:**
 A/D conversion rate: programmable 5 to 160 readings/sec.
 Step response:

Input Type	Input Update Rate						Readings/Sec
	5	10	20	40	80	160	
V//Resistance	400	200	100	50	30	20	msec response time *
Thermocouple	600	250	100	-	-	-	
RTD	1000	500	250	-	-	-	

* - max. to within 99% of final readout value (digital filter disabled)

Display update rate: 1 to 20 updates/sec.

Setpoint output on/off delay time: 0 to 3275 sec.

Analog output update rate: 0 to 10 sec

Max./Min. capture delay time: 0 to 3275 sec.

7. **DISPLAY MESSAGES:**

“OLOL” - Appears when measurement exceeds + signal range.

“ULUL” - Appears when measurement exceeds - signal range

“Short” - Appears when shorted sensor is detected. (RTD range only)

“OPEN” - Appears when open sensor is detected. (TC/RTD range only)

“.” - Appears when display values exceed + display range.

“-” - Appears when display values exceed - display range.

8. **INPUT CAPABILITIES:**

Current Input:

INPUT RANGE	ACCURACY * (18 to 28°C)	ACCURACY * (0 to 50°C)	IMPEDANCE	‡ RESOLUTION
± 250 µADC	0.03% of rdg + 0.03µA	0.12% of rdg + 0.04µA	1.11 KΩ	10nA
± 2.5 mADC	0.03% of rdg + 0.3µA	0.12% of rdg + 0.4µA	111 Ω	0.1µA
± 25 mADC	0.03% of rdg + 3µA	0.12% of rdg + 4µA	11.1 Ω	1µA
± 250 mADC	0.05% of rdg + 30µA	0.12% of rdg + 40µA	1.1 Ω	10µA
± 2 ADC	0.5% of rdg + 0.3mA	0.7% of rdg + 0.4mA	0.1 Ω	0.1mA

‡ Higher resolution can be achieved via input scaling.

Voltage Input:

INPUT RANGE	ACCURACY * (18 to 28°C)	ACCURACY * (0 to 50°C)	IMPEDANCE	‡ RESOLUTION
± 250 mVDC	0.03% of rdg + 30µV	0.12% of rdg + 40µV	451 KΩ	10µV
± 2.0 VDC	0.03% of rdg + 0.3mV	0.12% of rdg + 0.4mV	451 KΩ	0.1mV
± 10 VDC	0.03% of rdg + 3mV	0.12% of rdg + 4mV	451 KΩ	1mV
± 25 VDC	0.03% of rdg + 3mV	0.12% of rdg + 4mV	451 KΩ	1mV
± 100 VDC	0.3% of rdg + 30mV	0.12% of rdg + 40mV	451 KΩ	10mV
± 200 VDC	0.3% of rdg + 30mV	0.12% of rdg + 40mV	451 KΩ	10mV

‡ Higher resolution can be achieved via input scaling.

Temperature Inputs:

READOUT:

Scale: F or C

Offset Range: -199,999 to 999,999 display units.

Thermocouple Inputs:

Input Impedance: 20MΩ

Lead Resistance Effect: 0.03 µV/Ω

Max Continuous Overvoltage: 30 V

INPUT TYPE	RANGE	ACCURACY* (18 to 28 °C)	ACCURACY* (0 to 50 °C)	STANDARD	WIRE COLOR	
					ANSI	BS 1843
T	-200 to 400°C	1.2°C	2.1°C	ITS-90	(+) blue (-) red	(+) white (-) blue
E	-200 to 750°C	1.0°C	2.4°C	ITS-90	(+) purple (-) red	(+) brown (-) blue
J	-200 to 760°C	1.1°C	2.3°C	ITS-90	(+) white (-) red	(+) yellow (-) blue
K	-200 to 1250°C	1.3°C	3.4°C	ITS-90	(+) yellow (-) red	(+) brown (-) blue
R	0 to 1768°C	1.9°C	4.0°C	ITS-90	no standard	(+) white (-) blue
S	0 to 1768°C	1.9°C	4.0°C	ITS-90	no standard	(+) white (-) blue
B	150 to 300°C 300 to 1820°C	3.9°C 2.8°C	5.7°C 4.4°C	ITS-90	no standard	no standard
N	-200 to 1300°C	1.3°C	3.1°C	ITS-90	(+) orange (-) red	(+) orange (-) blue
C (W5/W26)	0 to 2315°C	1.9°C	6.1°C	ASTM E988-90**	no standard	no standard

RTD Inputs:

Type: 3 or 4 wire, 2 wire can be compensated for lead wire resistance

Excitation current: 100 ohm range: 136.5 µA ±10%

10 ohm range: 2.05 mA ±10%

Lead resistance: 100 ohm range: 10 ohm/lead max.

10 ohm range: 3 ohms/lead max.

Max. continuous overload: 30 V

INPUT TYPE	RANGE	ACCURACY* (18 to 28 °C)	ACCURACY* (0 to 50 °C)	STANDARD **
100 ohm Pt alpha = .00385	-200 to 850°C	0.4°C	1.6°C	IEC 751
100 ohm Pt alpha = .00392	-200 to 850°C	0.4°C	1.6°C	no official standard
120 ohm Nickel alpha = .00672	-80 to 259°C	0.2°C	0.5°C	no official standard
10 ohm Copper alpha = .00427	-110 to 260°C	0.4°C	0.9°C	no official standard

Resistance Inputs:

INPUT RANGE	ACCURACY * (18 to 28°C)	ACCURACY * (0 to 50°C)	COMPLIANCE	MAX CONT. OVERLOAD	‡ RESOLUTION
100 ohm	0.05% of rdg + 0.03 ohm	0.2% of rdg + 0.04 ohm	0.175 V	30 V	0.01 ohm
1000 ohm	0.05% of rdg + 0.3 ohm	0.2% of rdg + 0.4 ohm	1.75 V	30 V	0.1 ohm
10 Kohm	0.05% of rdg + 1 ohm	0.2% of rdg + 1.5 ohm	17.5 V	30 V	0.1 ohm

‡ Higher resolution can be achieved via input scaling.

* After 20 min. warm-up, @ 5 sample per second input rate. Accuracy is specified in two ways: Accuracy over an 18 to 28°C and 15 to 75% RH environment; and Accuracy over a 0 to 50°C and 0 to 85% RH (non condensing) environment. The specification includes the A/D conversion errors, linearization conformity, and thermocouple ice point compensation. Total system accuracy is the sum of unit and probe errors. Accuracy may be improved by field calibrating the unit readout at the temperature of interest.

** These curves have been corrected to ITS-90.

9. **EXCITATION POWER:** Jumper selectable
 Transmitter Power: +18 VDC, $\pm 5\%$ @ 50 mA max.
 Reference Voltage: + 2 VDC, $\pm 2\%$
 Compliance: 1K Ω load min (2 mA max)
 Temperature Coefficient: 40 ppm/ $^{\circ}$ C max.
 Reference Current: 1.05 mADC, $\pm 2\%$
 Compliance: 10 K Ω load max.
 Temperature Coefficient: 40 ppm/ $^{\circ}$ C max.

10. **USER INPUTS:** Two programmable user inputs
 Max. Continuous Input: 30 VDC
 Isolation To Sensor Input Common: Not isolated.
 Response Time: 12 msec. max.
 Logic State: User programmable (*UsrA/Et*) for sink/source (Lo/Hi)

INPUT STATE (<i>UsrA/Et</i>)	LO/SINK	HI/SOURCE
	20K Ω pull-up to +3.3V	20K Ω pull-down
Active	$V_{IN} < 1.1$ VDC	$V_{IN} > 2.2$ VDC
Inactive	$V_{IN} > 2.2$ VDC	$V_{IN} < 1.1$ VDC

11. **TOTALIZER:**
 Time Base: second, minute, hour, or day
 Batch: Can accumulate (gate) input display from a user input
 Time Accuracy: 0.01% typical
 Decimal Point: 0 to 0.0000
 Scale Factor: 0.001 to 65.000
 Low Signal Cut-out: -199,999 to 999,999
 Total: 6 digits on Line 1; 9 digits on Line 2
12. **CUSTOM LINEARIZATION:**
 Data Point Pairs: Selectable from 2 to 16
 Display Range: -199,999 to 999,999
 Decimal Point: 0 to 0.0000
13. **MEMORY:** Nonvolatile FRAM memory retains all programmable parameters and display values.

14. **ENVIRONMENTAL CONDITIONS:**
 Operating Temperature Range: 0 to 50 $^{\circ}$ C
 Storage Temperature Range: -40 to 60 $^{\circ}$ C
 Vibration to IEC 68-2-6: Operational 5-150 Hz, 2 g
 Shock to IEC 68-2-27: Operational 25 g (10 g relay)
 Operating and Storage Humidity: 0 to 85% max. RH non-condensing
 Altitude: Up to 2000 meters
15. **CERTIFICATIONS AND COMPLIANCES:**
CE Approved
 EN 61326-1 Immunity to Industrial Locations
 Emission CISPR 11 Class A
 IEC/EN 61010-1
 RoHS Compliant
 UL Listed: File #E179259
 Type 4X Indoor Enclosure rating (Face only)
 IP65 Enclosure rating (Face only)
 IP20 Enclosure rating (Rear of unit)
Refer to EMC Installation Guidelines section of the bulletin for additional information.
16. **CONNECTIONS:** High compression cage-clamp terminal block
 Wire Strip Length: 0.3" (7.5 mm)
 Wire Gauge Capacity: 26 to 16 AWG (0.14 to 1.5 mm²)
 Torque: 4.4-5.3 inch-lbs (0.5-0.6 N-m)
17. **CONSTRUCTION:** This unit is rated Type 4X/IP65 for indoor use only.
 IP20 Touch safe. Installation Category II, Pollution Degree 2. One piece bezel/ case. Flame resistant. Synthetic rubber keypad. Panel gasket and mounting clip included.
18. **WEIGHT:** 8 oz. (226.8 g)

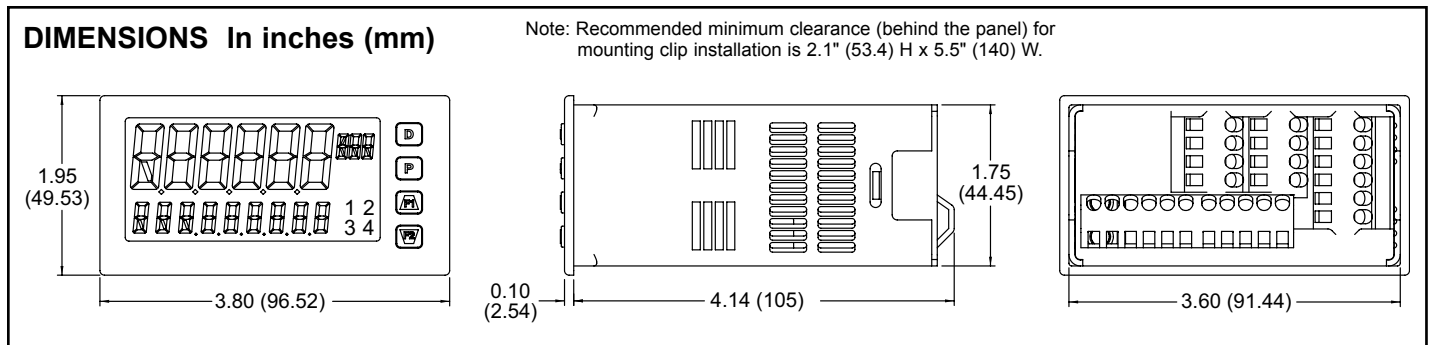

OPTION CARDS



WARNING: Disconnect all power to the unit before installing option cards.

Adding Option Cards

The PAX2 can be fitted with up to three option cards. The details for each option card can be reviewed in the specification section below. Only one card from each function type can be installed at a time. The function types include Setpoint Alarms (PAXCDS), Communications (PAXCDC), and Analog Output (PAXCDL). The option cards can be installed initially or at a later date.

COMMUNICATION CARDS (PAXCDC)

A variety of communication protocols are available for the PAX2. Only one PAXCDC card can be installed at a time. *Note: For Modbus communications use RS485 Communications Output Card and configure communication (TYPE) parameter for Modbus.*

SERIAL COMMUNICATIONS CARD: PAXCDC1_ and PAXCDC2_

Type: RS485 or RS232

Communication Type: Modbus ASCII, RLC Protocol (ASCII), and Modbus RTU

Isolation To Sensor & User Input Commons: 500 Vrms for 1 min.

Not Isolated from all other commons.

Data: 7/8 bits

Baud: 1200 to 38,400

Parity: no, odd or even

Bus Address: Selectable 0 to 99 (RLC Protocol), or 1 to 247 (Modbus Protocol), Max. 32 meters per line (RS485)

Transmit Delay: Selectable for 0 to 0.250 sec (+2 msec min)

DEVICENET™ CARD: PAXCDC30

Compatibility: Group 2 Server Only, not UCMM capable

Baud Rates: 125 Kbaud, 250 Kbaud, and 500 Kbaud

Bus Interface: Phillips 82C250 or equivalent with MIS wiring protection per DeviceNet™ Volume I Section 10.2.2.

Node Isolation: Bus powered, isolated node

Host Isolation: 500 Vrms for 1 minute between DeviceNet™ and unit input common.

PROFIBUS-DP CARD: PAXCDC50

Fieldbus Type: Profibus-DP as per EN 50170, implemented with Siemens SPC3 ASIC

Conformance: PNO Certified Profibus-DP Slave Device

Baud Rates: Automatic baud rate detection in the range 9.6 Kbaud to 12 Mbaud

Station Address: 0 to 125, set by rotary switches.

Connection: 9-pin Female D-Sub connector

Network Isolation: 500 Vrms for 1 minute between Profibus network and sensor and user input commons. Not isolated from all other commons.

SETPOINT CARDS (PAXCDS)

The PAX2 has 6 available setpoint alarm output option cards. Only one PAXCDS card can be installed at a time. (Logic state of the outputs can be reversed in the programming.) These option cards include:

DUAL RELAY CARD: PAXCDS10

Type: Two FORM-C relays

Isolation To Sensor & User Input Commons: 2000 Vrms for 1 min.

Contact Rating:

One Relay Energized: 5 amps @ 120/240 VAC or 28 VDC (resistive load).

Total current with both relays energized not to exceed 5 amps

Life Expectancy: 100 K cycles min. at full load rating. External RC snubber extends relay life for operation with inductive loads

QUAD RELAY CARD: PAXCDS20

Type: Four FORM-A relays

Isolation To Sensor & User Input Commons: 2300 Vrms for 1 min.

Contact Rating:

One Relay Energized: 3 amps @ 240 VAC or 30 VDC (resistive load).

Total current with all four relays energized not to exceed 4 amps

Life Expectancy: 100K cycles min. at full load rating. External RC snubber extends relay life for operation with inductive loads

QUAD SINKING OPEN COLLECTOR CARD: PAXCDS30

Type: Four isolated sinking NPN transistors.

Isolation To Sensor & User Input Commons: 500 Vrms for 1 min.

Not Isolated from all other commons.

Rating: 100 mA max @ $V_{SAT} = 0.7$ V max. $V_{MAX} = 30$ V

QUAD SOURCING OPEN COLLECTOR CARD: PAXCDS40

Type: Four isolated sourcing PNP transistors.

Isolation To Sensor & User Input Commons: 500 Vrms for 1 min.

Not Isolated from all other commons.

Rating: Internal supply: 18 VDC unregulated, 30 mA max. total

External supply: 30 VDC max., 100 mA max. each output

DUAL TRIAC/DUAL SSR DRIVE CARD: PAXCDS50

Triac:

Type: Isolated, zero crossing detection

Voltage: 260 VAC max., 20 VAC min.

Max Load Current: 1 Amp @ 25°C

0.75 Amp @ 50°C

Total load current with both triacs ON not to exceed 1.5 Amps

Min Load Current: 5 mA

Off State Leakage Current: 1 mA max @ 60 Hz

Operating Frequency: 20-400 Hz

SSR Drive:

Type: Two isolated sourcing PNP Transistors.

Isolation To Sensor & User Input Commons: 500 Vrms for 1 min.

Not Isolated from all other commons.

Rating:

Output Voltage: 18/24 VDC (unit dependent) $\pm 10\%$, 30 mA max. total both outputs

QUAD FORM C RELAY CARD: PAXCDS60

Type: Four FORM-C relays

Isolation To Sensor & User Input Commons: 500 Vrms for 1 min.

Contact Rating:

Rated Load: 3 Amp @ 30 VDC/125 VAC

Total Current With All Four Relays Energized not to exceed 4 amps

Life Expectancy: 100 K cycles min. at full load rating. External RC snubber extends relay life for operation with inductive loads

ALL SETPOINT CARDS

Response Time: See Update Rates step response specification on page 6; add 6 msec (typical) for relay card

LINEAR DC OUTPUT (PAXCDL)

Either a 0(4)-20 mA or 0-10 V retransmitted linear DC output is available from the analog output option card. The programmable output low and high scaling can be based on various display values. Reverse slope output is possible by reversing the scaling point positions.

ANALOG OUTPUT CARD: PAXCDL10

Types: 0 to 20 mA, 4 to 20 mA or 0 to 10 VDC

Isolation To Sensor & User Input Commons: 500 Vrms for 1 min.

Not Isolated from all other commons.

Accuracy: 0.17% of FS (18 to 28 °C); 0.4% of FS (0 to 50 °C)

Resolution: 1/3500

Compliance: 10 VDC: 10 K Ω load min., 20 mA: 500 Ω load max.

Powered: Self-powered

Update Response: See Update Rates specification on page 6.

1.0 INSTALLING THE METER

Installation

The PAX2 meets Type 4X/IP65 requirements when properly installed. The unit is intended to be mounted into an enclosed panel. Prepare the panel cutout to the dimensions shown. Remove the panel latch from the unit. Slide the panel gasket over the rear of the unit to the back of the bezel. The unit should be installed fully assembled. Insert the unit into the panel cutout.

While holding the unit in place, push the panel latch over the rear of the unit so that the tabs of the panel latch engage in the slots on the case. The panel latch should be engaged in the farthest forward slot possible. To achieve a proper seal, tighten the latch

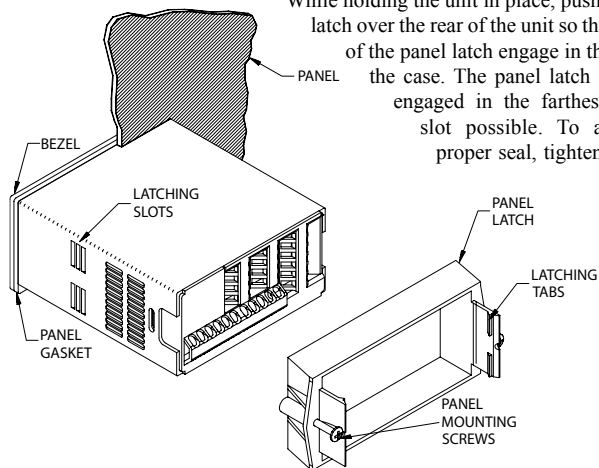

screws evenly until the unit is snug in the panel (Torque to approximately 7 in-lbs [79N-cm]). Do not over-tighten the screws.

Installation Environment

The unit should be installed in a location that does not exceed the operating temperature and provides good air circulation. Placing the unit near devices that generate excessive heat should be avoided.

The bezel should only be cleaned with a soft cloth and neutral soap product. Do NOT use solvents. Continuous exposure to direct sunlight may accelerate the aging process of the bezel.

Do not use tools of any kind (screwdrivers, pens, pencils, etc.) to operate the keypad of the unit.

PANEL CUT-OUT

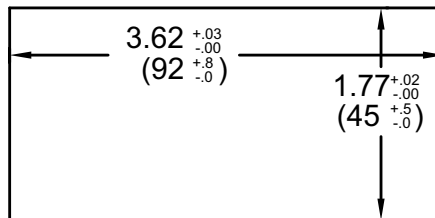

2.0 SETTING THE JUMPERS

The PAX2A has four jumpers that must be checked and/or changed prior to applying power. The following Jumper Selection Figures show an enlargement of the jumper area.

To access the jumpers, remove the unit base from the case by firmly squeezing and pulling back on the side rear finger tabs. This should lower the latch below the case slot (which is located just in front of the finger tabs). It is recommended to release the latch on one side, then start the other side latch.



Warning: Exposed line voltage exists on the circuit boards. Remove all power to the unit AND load circuits before removing the unit from its case.

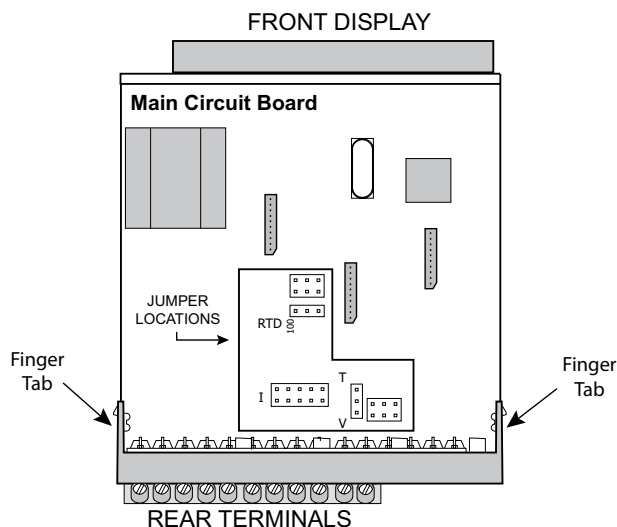

INPUT RANGE JUMPERS

Voltage Input

Two jumpers are used in configuring the unit for voltage/resistance. The first jumper, T/V, must be in the V (voltage) position. The second jumper is used to select the proper voltage input range. (This jumper is also used to select the current input range.) Select a range that is high enough to accommodate the maximum signal input to avoid overloads. For proper operation, the input range selected in programming must match the jumper setting.

Current Input

For current input, only one jumper must be configured to select the current range. This jumper is shared with the voltage input range. To avoid overloads, select the jumper position that is high enough to accommodate the maximum signal input level to be applied.

Note: The position of the T/V jumper does not matter when the unit is in the current input mode.

Temperature Input

For temperature measurement the T/V jumper must be in the T (temperature) position. For RTD sensors the RTD jumper must also be set.

Resistance Input

Three jumpers are used to configure the resistance input. The T/V jumper must be in the V (voltage) position, and the excitation jumper must be in the 1.05 mA REF position. The voltage/resistance jumper position is determined by the input range.

Excitation Output Jumper

This jumper is used to select the excitation range for the application. If excitation is not being used, it is not necessary to check or move this jumper.

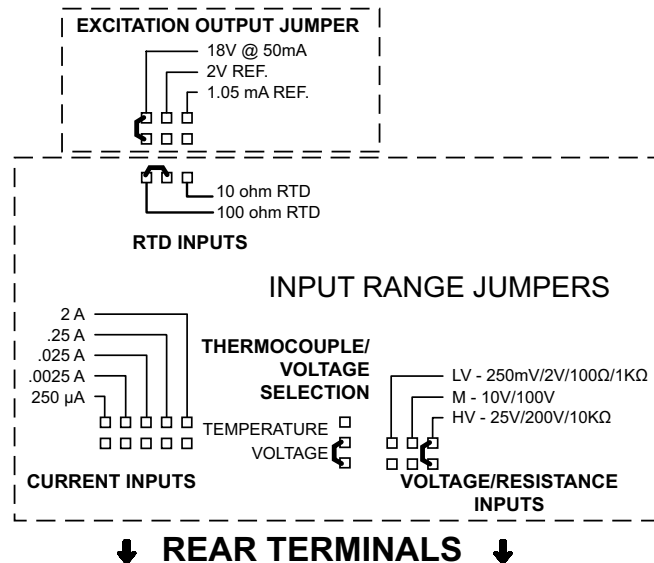

3.0 INSTALLING OPTION CARDS

The option cards are separately purchased cards that perform specific functions. These cards plug into the main circuit board of the unit. The option cards have many unique functions when used with the PAX2.



CAUTION: The option and main circuit boards contain static sensitive components. Before handling the cards, discharge static charges from your body by touching a grounded bare metal object. Ideally, handle the cards at a static controlled clean workstation. Dirt, oil or other contaminants that may contact the cards can adversely affect circuit operation.

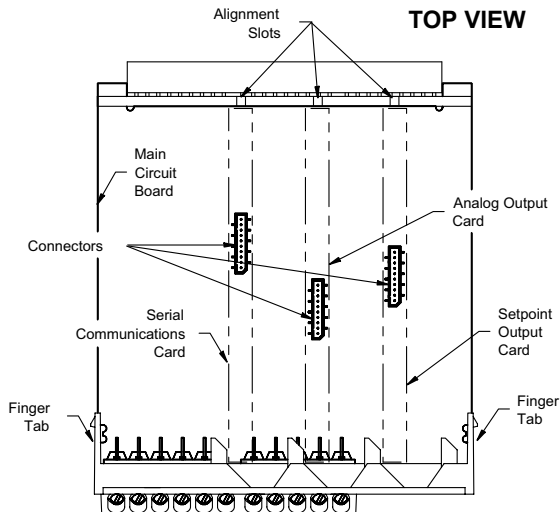

WARNING: Exposed line voltage exists on the circuit boards when power is applied. Remove all power to the unit AND load circuits before removing the unit from its case.

To Install:

1. For option card specific installation instructions, see the installation instructions provided with the option card being installed.
2. When handling the main circuit board, hold it by the rear cover. When handling the option card, hold it by the terminal block.
3. Remove the main assembly from the rear of the case by squeezing both finger holds on the rear cover and pulling the assembly out of the case. Or use a small screwdriver to depress the side latches and pull the main assembly out of the case. Do not remove the rear cover from the main circuit board.
4. Locate the appropriate option card slot location on the main circuit board. Align the option card terminal block with the slot terminal block position on the rear cover. Align the option card connector with the main circuit board option card connector and then press to fully engage the connector. Verify the tab on the option card rests in the alignment slot on the display board.
5. If installing an option card that includes a terminal block on the top of the option card, a knock-out on the top of the PAX case will need to be removed to allow the top terminal block to be inserted later. Locate the  shaped knock-out that aligns with the option slot for which the option card is being installed. Carefully remove the knock-out, being careful not to remove additional knock-outs. Trim knock-out tabs (gates) that remain on the case. The top terminal block on the option card will need to be removed before completing step 6.
6. Slide the assembly back into the case. Be sure the rear cover latches engage in the case. If option card includes a top terminal block, install top terminal block at this time.

4.0 WIRING THE METER

WIRING OVERVIEW

Electrical connections are made via screw-clamp terminals located on the back of the unit. All conductors should conform to the meter's voltage and current ratings. All cabling should conform to appropriate standards of good installation, local codes and regulations. It is recommended that the power supplied to the unit (DC or AC) be protected by a fuse or circuit breaker.

When wiring the unit, compare the numbers embossed on the back of the unit case against those shown in wiring drawings for proper wire position. Strip the wire, according to the terminal block specifications (stranded wires should be tinned with solder). Insert the lead into the correct terminal and then tighten the terminal until the wire is secure (Pull wire to verify tightness).

EMC INSTALLATION GUIDELINES

Although Red Lion Controls Products are designed with a high degree of immunity to Electromagnetic Interference (EMI), proper installation and wiring methods must be followed to ensure compatibility in each application. The type of the electrical noise, source or coupling method into a unit may be different for various installations. Cable length, routing, and shield termination are very important and can mean the difference between a successful or troublesome installation. Listed are some EMI guidelines for a successful installation in an industrial environment.

1. A unit should be mounted in a metal enclosure, which is properly connected to protective earth.
2. Use shielded cables for all Signal and Control inputs. The shield connection should be made as short as possible. The connection point for the shield depends somewhat upon the application. Listed below are the recommended methods of connecting the shield, in order of their effectiveness.
 - a. Connect the shield to earth ground (protective earth) at one end where the unit is mounted.
 - b. Connect the shield to earth ground at both ends of the cable, usually when the noise source frequency is over 1 MHz.
3. Never run Signal or Control cables in the same conduit or raceway with AC power lines, conductors, feeding motors, solenoids, SCR controls, and heaters, etc. The cables should be run through metal conduit that is properly grounded. This is especially useful in applications where cable runs are long

and portable two-way radios are used in close proximity or if the installation is near a commercial radio transmitter. Also, Signal or Control cables within an enclosure should be routed as far away as possible from contactors, control relays, transformers, and other noisy components.

4. Long cable runs are more susceptible to EMI pickup than short cable runs.
5. In extremely high EMI environments, the use of external EMI suppression devices such as Ferrite Suppression Cores for signal and control cables is effective. The following EMI suppression devices (or equivalent) are recommended:

Fair-Rite part number 0443167251 (RLC part number FCOR0000)

Line Filters for input power cables:

Schaffner # FN2010-1/07 (Red Lion Controls # LFIL0000)

6. To protect relay contacts that control inductive loads and to minimize radiated and conducted noise (EMI), some type of contact protection network is normally installed across the load, the contacts or both. The most effective location is across the load.
 - a. Using a snubber, which is a resistor-capacitor (RC) network or metal oxide varistor (MOV) across an AC inductive load is very effective at reducing EMI and increasing relay contact life.
 - b. If a DC inductive load (such as a DC relay coil) is controlled by a transistor switch, care must be taken not to exceed the breakdown voltage of the transistor when the load is switched. One of the most effective ways is to place a diode across the inductive load. Most RLC products with solid state outputs have internal zener diode protection. However external diode protection at the load is always a good design practice to limit EMI. Although the use of a snubber or varistor could be used.
RLC part numbers: Snubber: SNUB0000
Varistor: ILS11500 or ILS23000
7. Care should be taken when connecting input and output devices to the instrument. When a separate input and output common is provided, they should not be mixed. Therefore a sensor common should NOT be connected to an output common. This would cause EMI on the sensitive input common, which could affect the instrument's operation.

Visit RLC's web site at <http://www.redlion.net/emf> for more information on EMI guidelines, Safety and CE issues as they relate to Red Lion Controls products.

4.1 POWER WIRING

AC Power

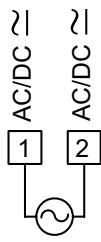

DC Power

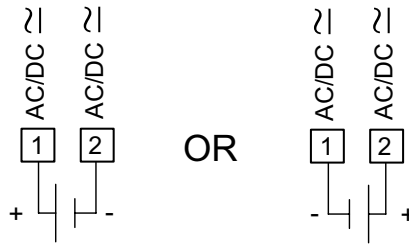

The power supplied to the unit shall employ a 15 Amp UL approved circuit breaker for AC input and a 1 Amp, 250 V UL approved fuse for DC input. It shall be easily accessible and marked as a disconnecting device to the installed unit. This device is not directly intended for connection to the mains without a reliable means to reduce transient over-voltages to 1500 V.

4.2 VOLTAGE/RESISTANCE/CURRENT INPUT SIGNAL WIRING

IMPORTANT: Before connecting signal wires, the Input Range Jumpers and Excitation Jumper should be verified for proper position.

Voltage Signal

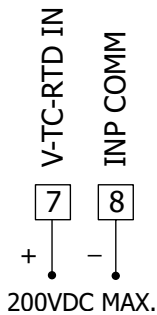

Process/Current Signal (external powered)

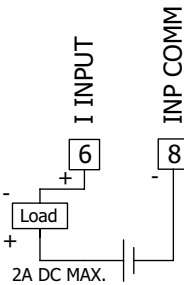

Process/Current Signal (2 wire requiring 18V excitation)

Excitation Jumper: 18 V

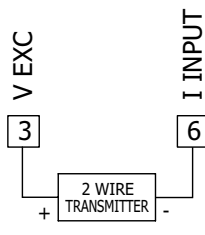

Current Signal (3 wire requiring 18 V excitation)

Terminal 3: +Volt supply
Terminal 6: +ADC (signal)
Terminal 8: -ADC (common)
Excitation Jumper: 18 V

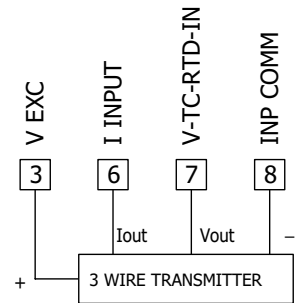

Voltage Signal (3 wire requiring 18 V excitation)

Terminal 3: +Volt supply
Terminal 7: +VDC (signal)
Terminal 8: -VDC (common)
Excitation Jumper: 18 V

Resistance Signal (2 wire requiring excitation)

Terminal 3: Jumper to terminal 7
Terminal 7: Resistance
Terminal 8: Resistance
Excitation Jumper: 1.05 mA REF.
T/V Jumper: V position
Voltage/Resistance Input Jumper: Set per input signal

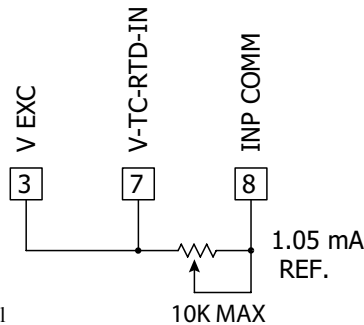

Potentiometer Signal as Voltage Input (3 wire requiring excitation)

Terminal 3: High end of pot.
Terminal 7: Wiper
Terminal 8: Low end of pot.
Excitation Jumper: 2 V REF.
T/V Jumper: V
Voltage/Resistance Input Jumper: 2 Volt
Module 1 Input Range: 2 Volt
Note: The Apply signal scaling style should be used because the signal will be in volts.

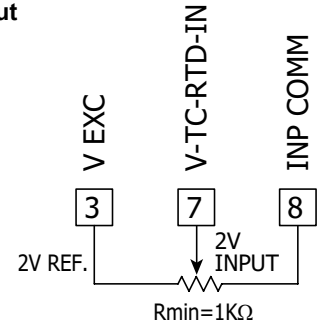

CAUTION: Sensor input common is NOT isolated from user input common. In order to preserve the safety of the application, the sensor input common must be suitably isolated from hazardous live earth referenced voltages; or input common must be at protective earth ground potential. If not, hazardous live voltage may be present at the User Inputs and User Input Common terminals. Appropriate considerations must then be given to the potential of the user input common with respect to earth common; and the common of the isolated option cards with respect to input common.

4.3 TEMPERATURE INPUT SIGNAL WIRING

IMPORTANT: Before connecting signal wires, verify the T/V Jumper is in the T position.

Thermocouple

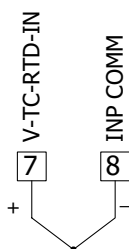

3-Wire RTD

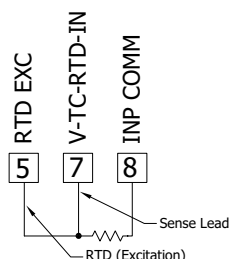

2-Wire RTD

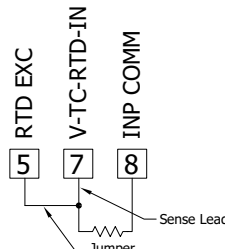

CAUTION: Sensor input common is NOT isolated from user input common. In order to preserve the safety of the application, the sensor input common must be suitably isolated from hazardous live earth referenced voltages; or input common must be at protective earth ground potential. If not, hazardous live voltage may be present at the User Inputs and User Input Common terminals. Appropriate considerations must then be given to the potential of the user input common with respect to earth common; and the common of the isolated option cards with respect to input common.

4.4 USER INPUT WIRING

If not using User Inputs, then skip this section. Only the appropriate User Input terminal has to be wired.

Sinking Logic ($USrREt L0$)

When the $USrREt$ parameter is programmed to $L0$, the user inputs are internally pulled up to +3.3 V with 20 K Ω resistance. The input is active when it is pulled low (<1.1 V).

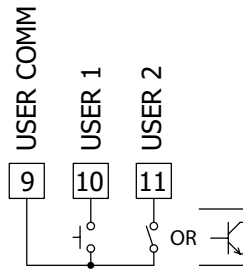

Sourcing Logic ($USrREt H1$)

When the $USrREt$ parameter is programmed to $H1$, the user inputs are internally pulled down to 0 V with 20 K Ω resistance. The input is active when a voltage greater than 2.2 VDC is applied.

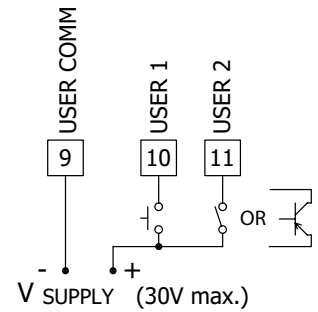

4.5 SETPOINT (ALARMS) WIRING

4.6 SERIAL COMMUNICATION WIRING

4.7 ANALOG OUTPUT WIRING

See appropriate option card bulletin for wiring details.

5.0 REVIEWING THE FRONT BUTTONS AND DISPLAY

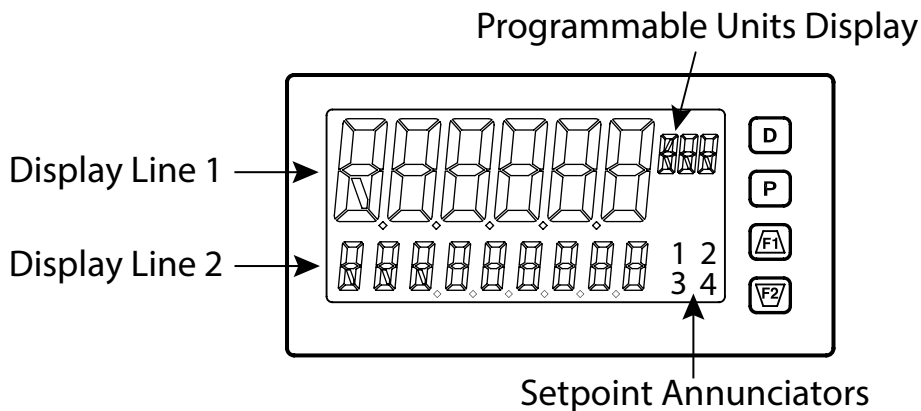

KEY DISPLAY MODE OPERATION

D	Index Line 2 through enabled, max/min/input/total, readouts
P	Access the parameter and hidden display loops
$F1$	Function key 1; hold for 3 seconds for second function 1*
$F2$	Function key 2; hold for 3 seconds for second function 2*

PROGRAMMING MODE OPERATION

	Quick exit to display mode
	Access the programming parameter menus, store selected parameter and index to next parameter
	Increment selected parameter value
	Decrement selected parameter value

*Factory setting for F1 and F2 is no mode

The PAX2A display consists of a large, 6-digit upper display referred to as Line 1 and a smaller 9-digit lower display referred to as Line 2. Line 1 can be configured to show one of several values, including the main input reading, min, max, setpoints or total values. Line 2 can be used to display several selectable values including; input value, min, max, total, list, setpoint values, and other values. For these values the mnemonics is shown in the left most digits of Line 2. To the right of Line 1 is a Programmable Units Display. This display consists of 3 programmable digits that are user defined as mnemonics for Line 1.

PAX2A DISPLAY LOOPS

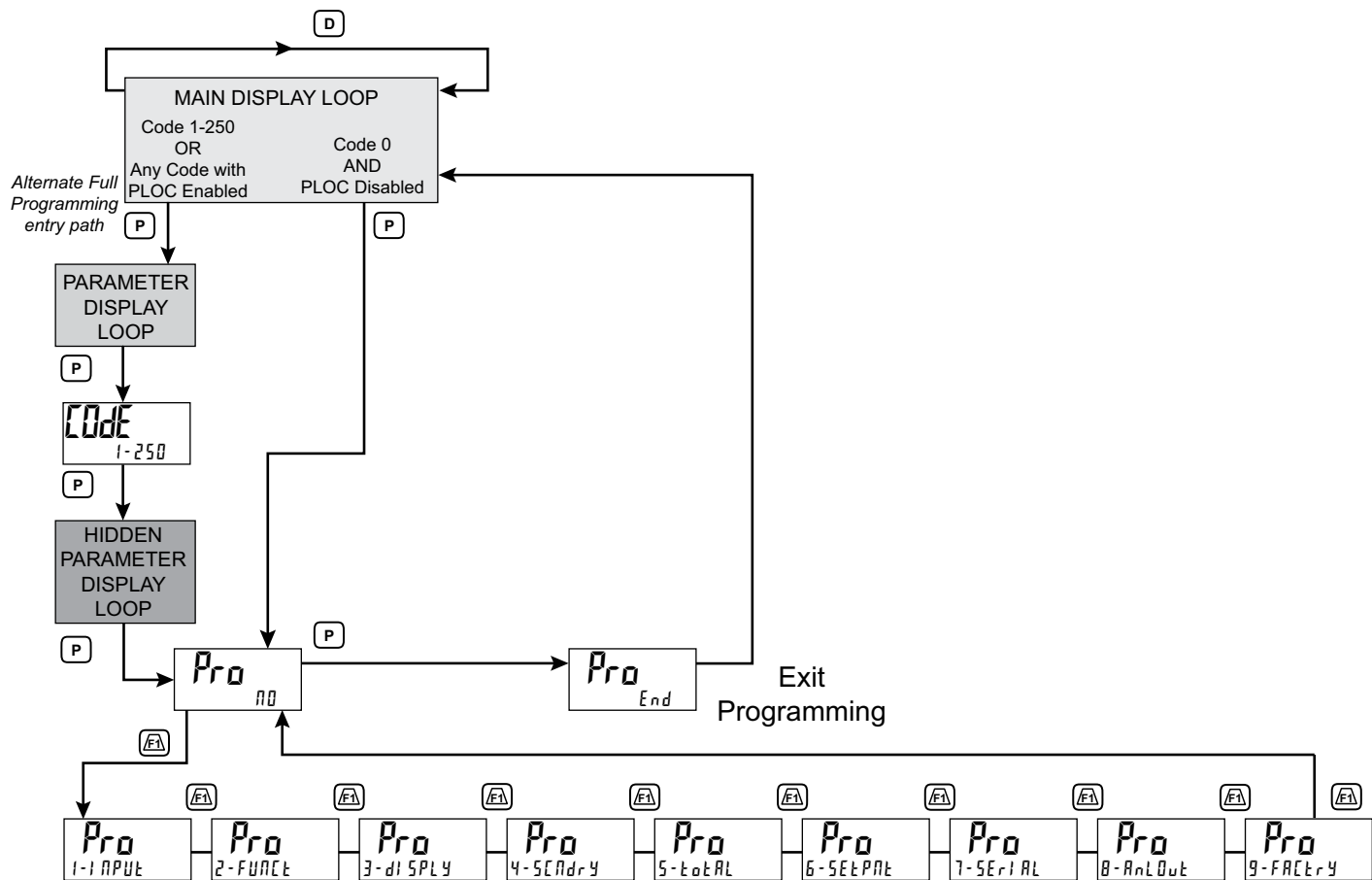

* Pressing "D" at any time exits back to the Main Display Loop.

PAX2A DISPLAY LOOPS

The PAX2A offers three display loops to allow users quick access to needed information. These display loops are available when the unit is in the normal display mode. By pressing the **D** key, the user can view parameters such as the Total, Min, Max or the Input in the Main Display Loop. Display selections are fully programmable and are viewed on the 9 digit line of the unit.

Pressing the **P** key with no security code (Code 0) will put the unit directly into the programming mode. When a security code is programmed (Code 1-250), pressing the **P** key will allow access to the Parameter Display Loop. This loop is where the parameters like setpoint values are normally put for general public access. Parameters in this loop can only be viewed/changed if enabled in the unit programming. After all the parameters in the Parameter Display Loop are viewed, an additional press of the **P** key will bring up the security code (Code 0). Access the Hidden Parameter Display Loop by entering the selected security code. In this loop displayed parameters can be changed. Combining the two parameter loops provides an area for parameters that require general access and/or protected or secure access depending on your application needs.

During programming of the unit you will need to select if a value is to be displayed or not. If the value is not required, select the lock mode (Lk). If you decide to display the value, you will need to assign it to a loop; **D** for the Main Display Loop, **P** for the Parameter Display Loop, and **HidE** for the Hidden Display Loop. In the case of the parameters, such as the setpoint values you will also need to decide if the value can only be read (rEd) or entered (Ent). The **F1** and **F2** key will increment or decrement the value when the edit mode is active. After the change, press the **P** key to save and move to the next value. Any values placed in the Hidden Parameter Loop can be changed as they are protected by the security code. While in the parameter display and hidden parameter loops, pressing the **D** key will return the unit to the main display.

There are selections in the programming that allow for the values to be reset. When the **P** key is pushed on a resettable display, the unit will display the value mnemonic and "n0" (if Line 2 value was set for "d-Ent" in "3-dISPL"). Pressing the **F1** and **F2** keys will toggle between "n0" and "YES". Pressing the **P** key with "YES" displayed will cause the reset action to be performed.

The **P**, Parameter key is used to scroll among the programmed Line 2 parameter values when at the main display or to step through the parameter loop and hidden parameter loop. It is used as the enter key when the unit is in the programming mode.

Numerical Value Entry

If the parameter is programmed for enter (Ent), the **F1** and **F2** keys are used to change the parameter values in any of the display loops.

The **F1** and **F2** keys will increment or decrement the parameter value. When the arrow key is pressed and held, the value automatically scrolls. The longer the arrow key is held the faster the value scrolls.

For large value changes, press and hold the **F1** or **F2** key. While holding that key, momentarily press the **D** key and the value scrolls by 1000's as the arrow key is held. Releasing the arrow key removes the 1000's scroll feature. The arrow keys can then be used to make small value changes as described above.

Main Display Loop

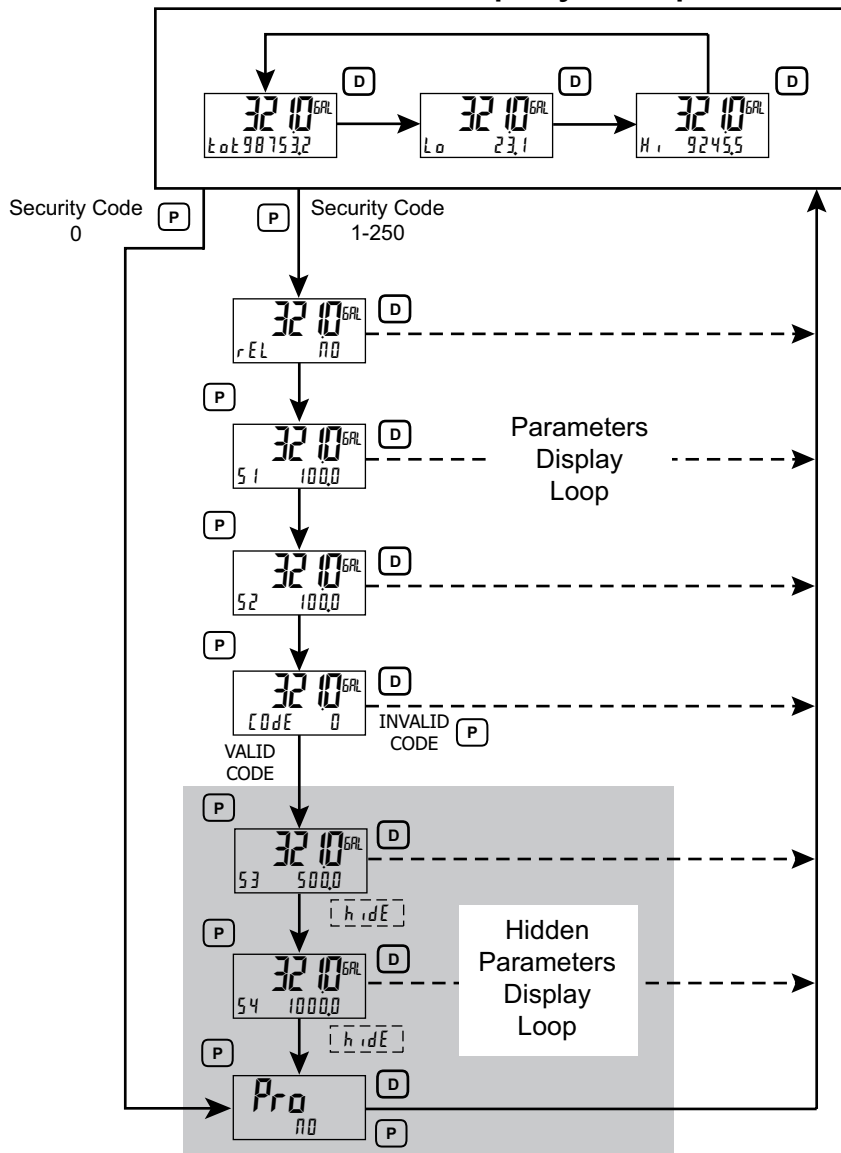

6.0 PROGRAMMING THE PAX2A

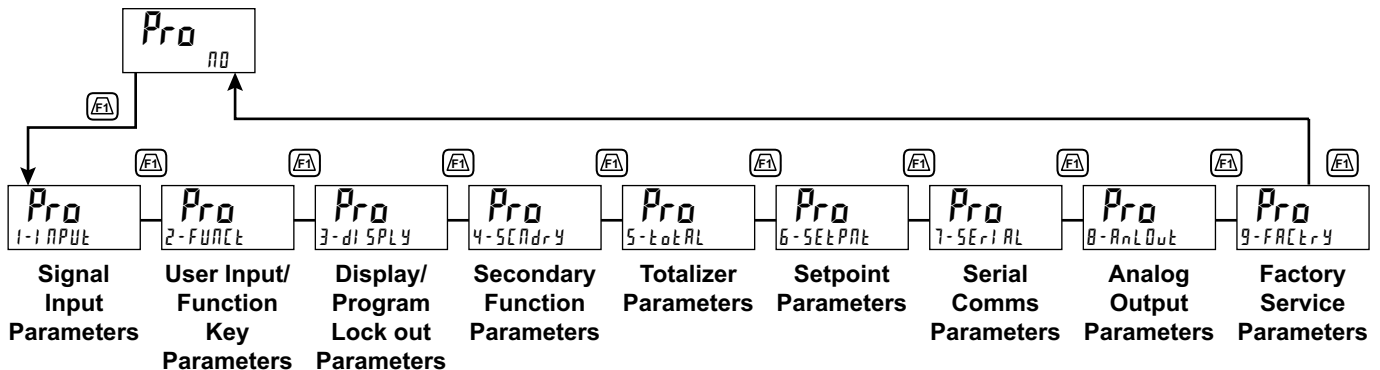

MODULE 1 - INPUT SETUP PARAMETERS (1-1 INPUT)

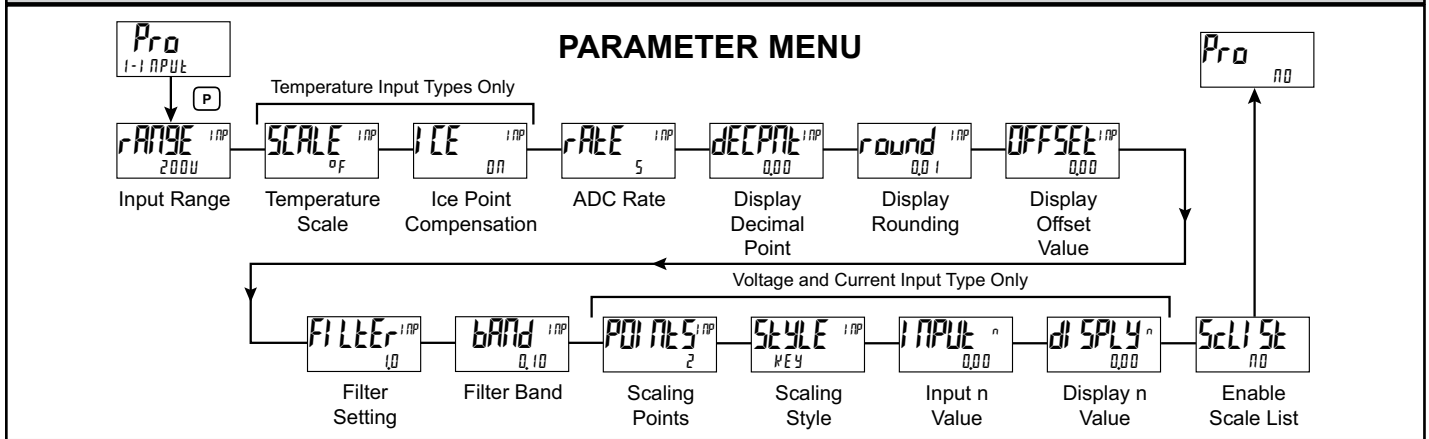

INPUT RANGE



250 μ A	2V	1000 Ω	tc-r	r392
0.0025A	10V	10000 Ω	tc-5	r672
0.025A	25V	tc-t	tc-b	r427
0.25A	100V	tc-E	tc-n	
2A	200V	tc-d	tc-L	
0.25V	100 Ω	tc-V	r385	

Select the desired input range.

ROUNDING INCREMENT



1	2	5	
10	20	50	100

Rounding selections other than one, cause the Input Display to 'round' to the nearest rounding increment selected (ie. rounding of '5' causes 122 to round to 120 and 123 to round to 125). Rounding starts at the least significant digit of the Input Display. Remaining parameter entries (scaling point values, setpoint values, etc.) are not automatically adjusted to this display rounding selection.

TEMPERATURE SCALE

For TC and RTD Input Range Selection only.



OF OF

Select the temperature scale. This selection applies for Input, MAX, MIN, and TOT displays. If changed, those parameters that relate to the temperature scale should be checked.

DISPLAY OFFSET



- 999999 to 999999

The display can be corrected with an offset value. This can be used to compensate for probe errors, errors due to variances in probe placement or adjusting the readout to a reference thermometer. This value is automatically updated after a Zero Display to show how far the display is offset. A value of zero will remove the affects of offset.

ICE POINT COMPENSATION

For TC Input Range Selection only.



ON OFF

This parameter turns the internal ice point compensation on or off. Normally, the ice point compensation is on. If using external compensation, set this parameter to off. In this case, use copper leads from the external compensation point to the unit.

DIGITAL FILTERING



0.0 to 25.0 seconds

The input filter setting is a time constant expressed in tenths of a second. The filter settles to 99% of the final display value within approximately 3 time constants. This is an Adaptive Digital Filter which is designed to steady the Input Display reading. A value of '0' disables filtering.

INPUT UPDATE RATE (/SEC)



5 10 20 40 80 160

Select the ADC conversion rate (conversions per second). Temperature inputs can not be set higher than 20 updates per second. The selection does not affect the display update rate, however it does affect setpoint and analog output response time. The default factory setting of 5 is recommended for most applications. Selecting a fast update rate may cause the display to appear very unstable.

FILTER BAND

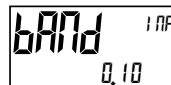

0 to 25.0 display units

The digital filter will adapt to variations in the input signal. When the variation exceeds the input filter band value, the digital filter disengages. When the variation becomes less than the band value, the filter engages again. This allows for a stable readout, but permits the display to settle rapidly after a large process change. The value of the band is in display units, independent of the Display Decimal Point position. A band setting of '0' keeps the digital filter permanently engaged.

DECIMAL RESOLUTION (Display Units)



0 to 0.00000 (curr/volt)
0 to 0.0 (temp)

Select desired display resolution. The available selections are dependent on the Input Range selected (RANGE).

SCALING POINTS



2 to 16

Linear - Scaling Points (2)

For linear processes, only 2 scaling points are necessary. It is recommended

that the 2 scaling points be at opposite ends of the input signal being applied. The points do not have to be the signal limits. Display scaling will be linear between and continue past the entered points up to the limits of the Input Signal Jumper position. Each scaling point has a coordinate-pair of Input Value (*I n P U T n*) and an associated desired Display Value (*d i S P L Y n*).

Nonlinear - Scaling Points (Greater than 2)

For non-linear processes, up to 16 scaling points may be used to provide a piece-wise linear approximation. (The greater the number of scaling points used, the greater the conformity accuracy.) The Input Display will be linear between scaling points that are sequential in program order. Each scaling point has a coordinate-pair of Input Value (*I n P U T n*) and an associated desired Display Value (*d i S P L Y n*). Data from tables or equations, or empirical data could be used to derive the required number of segments and data values for the coordinate pairs. In the Crimson software, several linearization equations are available.

SCALING STYLE

This parameter does not apply for thermocouple or RTD input ranges.



KEY key-in data
APPLY apply signal

If Input Values and corresponding Display Values are known, the Key-in (**KEY**) scaling style can be used. This allows scaling without the presence of the input signal. If Input Values have to be derived from the actual input signal source or simulator, the Apply (**APPLY**) scaling style must be used.

INPUT VALUE FOR SCALING POINT 1



- 199999 to 999999

For Key-in (**KEY**), enter the known first Input Value by using the **F1** or **F2** arrow keys. (The Input Range selection sets up the decimal location for the Input Value). For Apply (**APPLY**), the existing programmed value will appear. If this is acceptable, press the **P** key to save and continue to the next parameter. To update/program this value, apply the input signal that corresponds to Scaling Point 1, press **F2** key and the actual signal value will be displayed. Then press the **P** key to accept this value and continue to the next parameter.

DISPLAY VALUE FOR SCALING POINT 1



- 199999 to 999999

Enter the first coordinating Display Value by using the arrow keys. This is the same for **KEY** and **APPLY** scaling styles. The decimal point follows the **DECIMAL** selection.

INPUT VALUE FOR SCALING POINT 2



- 199999 to 999999

For Key-in (**KEY**), enter the known second Input Value by using the **F1** or **F2** arrow keys. For Apply (**APPLY**), the existing programmed value will appear. If this is acceptable, press the **P** key to save and continue to the next parameter. To update/program this value, apply the input signal that corresponds to Scaling Point 2, press **F2** key and the actual signal value will be displayed. Then press the **P** key to accept this value and continue to the next parameter. (Follow the same procedure if using more than 2 scaling points.)

DISPLAY VALUE FOR SCALING POINT 2



- 199999 to 999999

Enter the second coordinating Display Value by using the **F1** or **F2** arrow keys. This is the same for **KEY** and **APPLY** scaling styles. (Follow the same procedure if using more than 2 scaling points.)

ENABLE SCALE LIST



NO YES

When enabled, a second list of scaling points is active in the selected parameter list for List A and List B.

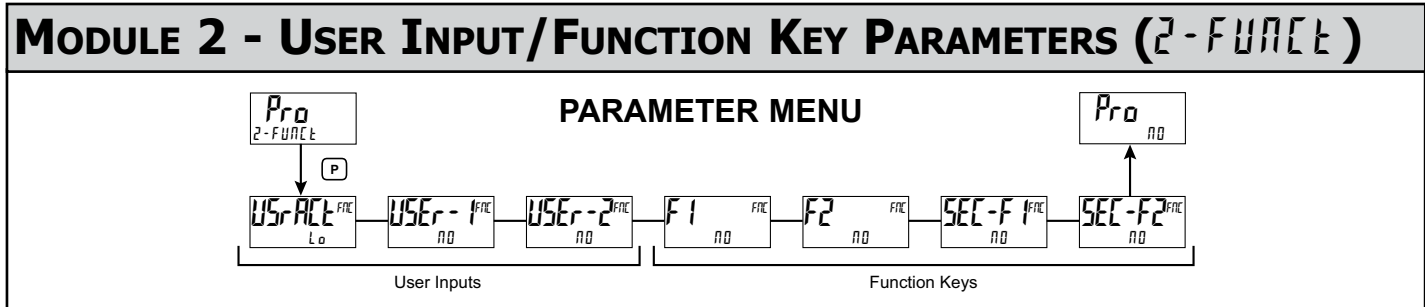

The two user inputs are individually programmable to perform specific unit control functions. While in the Display Mode or Program Mode, the function is executed the instant the user input transitions to the active state. The front panel function keys, **F1** and **F2**, are also individually programmable to perform specific unit control functions. While in the Display Mode, the primary function is executed the instant the key is pressed. Holding the function key for three seconds executes a secondary function. It is possible to program a secondary function without a primary function.

In most cases, if more than one user input and/or function key is programmed for the same function, the maintained (level trigger) actions will be performed while at least one of those user inputs or function keys are activated. The momentary (edge trigger) actions will be performed every time any of those user inputs or function keys transition to the active state.

Note: In the following explanations, not all selections are available for both user inputs and front panel function keys. Displays are shown with each selection. Those selections showing both displays are available for both. If a display is not shown, it is not available for that selection. *USER-n* will represent both user inputs. *Fn* will represent both function keys and second function keys.

USER INPUT ACTIVE STATE



L0 H1

Select the desired active state for the User Inputs. Select **L0** for sink input, active low. Select **H1** for source input, active high.

NO FUNCTION

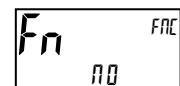

No function is performed if activated. This is the factory setting for all user inputs and function keys.

PROGRAMMING MODE LOCK-OUT



Programming Mode is locked-out, as long as activated (maintained action). A security code can be configured to allow programming access during lock-out.

ZERO (TARE) DISPLAY



The Zero (Tare) Display provides a way to zero the Input Display value at various input levels, causing future Display readings to be offset. This function is useful in weighing applications where the container or material on the scale should not be included in the next measurement value. When activated (momentary action), *rESEt* flashes and the Display is set to zero. At the same time, the Display value (that was on the display before the Zero Display) is subtracted from the Display Offset Value and is automatically stored as the new Display Offset Value. If another Zero (tare) Display is performed, the display will again change to zero and the Display offset value will shift accordingly.

RELATIVE/ABSOLUTE DISPLAY

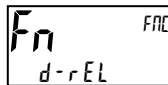

This function will switch the Input Display between Relative and Absolute. The Relative is a net value that includes the Display Offset Value. The Input Display will normally show the Relative unless switched by this function. Regardless of the display selected, all unit functions continue to operate based on relative values. The Absolute is a gross value (based on Module 1 DSP and INP entries) without the Display Offset Value. The Absolute display is selected as long as the user input is activated (maintained action) or at the transition of the function key (momentary action). When the user input is released, or the function key is pressed again, the input display switches back to Relative display. (*AbS*) or (*rEL*) is momentarily displayed at transition to indicate which display is active.

HOLD DISPLAY

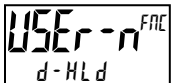

The active display is held but all other unit functions continue as long as activated (maintained action).

HOLD ALL FUNCTIONS

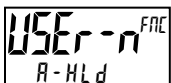

The unit disables processing the input, holds all display contents, and locks the state of all outputs as long as activated (maintained action). The serial port continues data transfer.

SYNCHRONIZE METER READING



The unit suspends all functions as long as activated (maintained action). When the user input is released, the unit synchronizes the restart of the A/D with other processes or timing events.

STORE BATCH READING IN TOTALIZER



The Input Display value is added (batched) to the Totalizer at transition to activate (momentary action) and Line 2 flashes *bAtch*. The Totalizer retains a running sum of each batch operation until the Totalizer is reset. When this function is selected, the normal operation of the Totalizer is overridden and only batched Input Display values accumulate in the Totalizer.

SELECT TOTALIZER DISPLAY



The Totalizer display appears on Line 2 as long as activated (maintained action). When the user input is released, the previously selected display is returned. The **D** or **P** keys override and disable the active user input. The Totalizer continues to function including associated outputs independent of being displayed.

RESET TOTALIZER



When activated (momentary action), *rESEt* flashes and the Totalizer resets to zero. The Totalizer then continues to operate as it is configured. This selection functions independent of the selected display.

RESET AND ENABLE TOTALIZER



When activated (momentary action), *rESEt* flashes and the Totalizer resets to zero. The Totalizer continues to operate while active (maintained action). When the user input is released, the Totalizer stops and holds its value. This selection functions independent of the selected display.

ENABLE TOTALIZER



The Totalizer continues to operate while active (maintained action). When the user input is released, the Totalizer stops and holds its value. This selection functions independent of the selected display.

SELECT MAXIMUM DISPLAY



The Maximum display appears on Line 2 as long as activated (maintained). When the user input is released, the previously selected display is returned. The **D** or **P** keys override and disable the active user input. The Maximum continues to function independent of being displayed.

RESET MAXIMUM DISPLAY

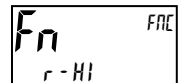
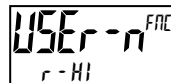

When activated (momentary action), *rESEt* flashes and the Maximum resets to the present Input Display value. The Maximum function then continues from that value. This selection functions independent of the selected display.

SELECT MINIMUM DISPLAY



The Minimum display appears on Line 2 as long as activated (maintained). When the user input is released, the previously selected display is returned. The **D** or **P** keys override and disable the active user input. The Minimum continues to function independent of being displayed.

RESET MINIMUM DISPLAY

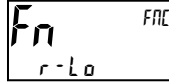

When activated (momentary action), *rESEt* flashes and the Minimum resets to the present Input Display value. The Minimum function then continues from that value. This selection functions independent of the selected display.

RESET MAXIMUM AND MINIMUM DISPLAY

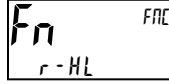

When activated (momentary action), *rESEt* flashes and the Maximum and Minimum readings are set to the present Input Display value. The Maximum and Minimum function then continues from that value. This selection functions independent of the selected display.

DISPLAY SELECT



When activated (momentary action), Line 2 advances to the next display that is not locked out from the Display Mode.

ADJUST DISPLAY INTENSITY

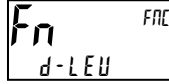

When activated (momentary action), the display intensity changes to the next intensity level.

CHANGE DISPLAY COLOR



When activated (momentary action), Line 1 will change color.

SELECT PARAMETER LIST



Two lists of input scaling points and setpoint values (including band and deviation) are available. The two lists are named *LISt-A* and *LISt-B*. If a user input is used to select the list then *LISt-A* is selected when the user input is not active and *LISt-B* is selected when the user input is active (maintained action). If a front panel key is used to select the list then the list will toggle for each key press (momentary action). The display will only indicate which list is active when the list is changed. To program the values for *LISt-A* and *LISt-B*, first complete the programming of all the parameters. Exit programming and switch to the other list. Re-enter programming and enter the desired values for the input scaling points, setpoints, band, and deviation if used.

SETPOINT SELECTIONS

The following selections are functional only with a Setpoint option card installed.

- r-1* - Reset Setpoint 1 (Alarm 1)
- r-2* - Reset Setpoint 2 (Alarm 2)
- r-3* - Reset Setpoint 3 (Alarm 3)
- r-4* - Reset Setpoint 4 (Alarm 4)
- r-34* - Reset Setpoint 3 & 4 (Alarm 3 & 4)
- r-234* - Reset Setpoint 2, 3 & 4 (Alarm 2, 3 & 4)
- r-ALL* - Reset All Setpoints (Alarms 1-4)

PRINT REQUEST

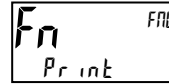

The unit issues a block print through the serial port when activated, and the serial type is set to *rLf*. The data transmitted during a print request and the serial type is programmed in Module 7. If the user input is still active after the transmission is complete (about 100 msec), an additional transmission occurs. As long as the user input is held active, continuous transmissions occur.

MODULE 3 - DISPLAY PARAMETERS (3-d1 SPLY)

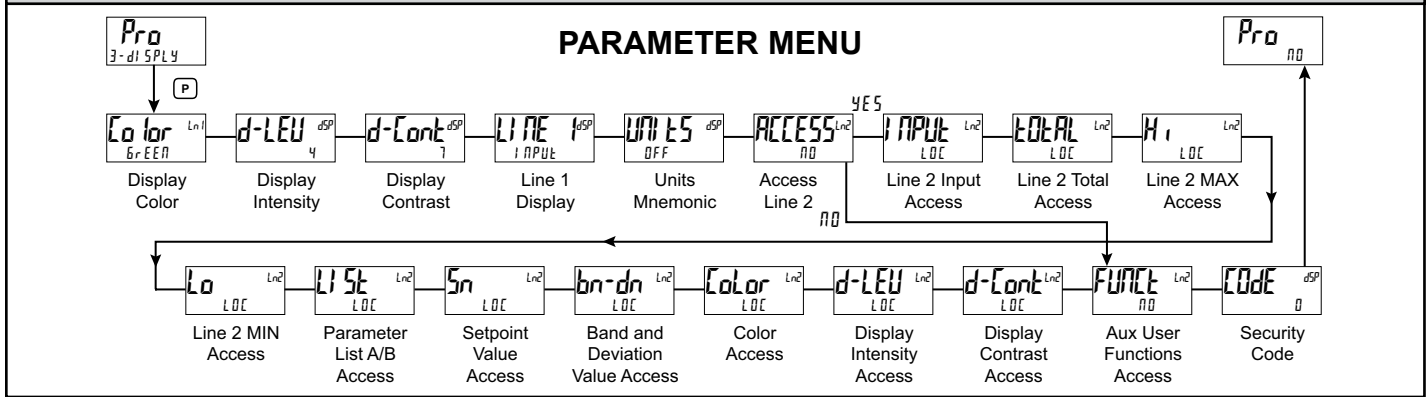

Module 3 is the programming of the Main Display Loop, Parameter Display Loop, Hidden Parameter Loop, and Full Programming lock-out. The large upper display line value is configured by the "LINE 1" parameter. The Units mnemonic can be used to assign a custom display mnemonic to the upper display value. When in the Main Display Loop, the available Line 2 displays (items configured for *d-rEd* or *d-ENt*) can be consecutively read on lower display by repeatedly pressing the **D** key. A left justified 3 character mnemonic indicates which parameter value is being shown on the lower display. When in the Main Display Loop the User keys **F1** and **F2** function as programmed in Module 2.

The Parameter display loop items can be accessed by pressing the **P** key. To edit a main display line item, that is configured as *d-ENt*, the **P** key is pushed and the unit enters a parameter edit mode in which the **F1** and **F2** key increments or decrements the value.

Full Programming Mode permits all parameters to be viewed and modified. This Programming Mode can be locked with a security code and/or user input.

LINE 1 DISPLAY COLOR



GREEN rEd ORANGE

Enter the desired Display Line 1 and programmable Units Display color.

DISPLAY INTENSITY LEVEL



0 to 4

Enter the desired Display Intensity Level (0-4) by using the arrow keys. The display will actively dim or brighten as the levels are changed. This parameter also appears in the Parameter Display Loop when enabled.

DISPLAY CONTRAST LEVEL



0 to 15

Enter the desired Display Contrast Level (0-15) by using the arrow keys. The display contrast / viewing angle will actively move up or down as the levels are changed. This parameter also appears in the Parameter Display Loop when enabled.

LINE 1 DISPLAY



INPUT total HI Lo
51 52 53 54 NONE

Select the value to be assigned to the primary or top line of the unit display.

UNITS MNEMONIC



OFF LIST

This parameter allows programming of the display mnemonics characters. Three individual characters may be selected from a preprogrammed list. The list includes:

. A B C D E F G H I J K L N O P Q R S T U V Y Z 0 1 2
3 4 5 6 7 8 9 c e g h i n o q r u - ° blank

LINE 2 MAIN, SECONDARY & HIDDEN DISPLAY LOOP ACCESSIBLE ITEMS



NO YES

Select **YES** to program the display Line 2 accessible values. The default setting of **NO** bypasses the programming of these values to shorten the module.

All of the individual Line 2 settings are retained.

The following values can be made accessible on Line 2 of the Main (**D** key), Parameter (**P** key) and Hidden (**P** key following code entry) Display Loops.

Each of the following parameters can be configured for one of the following settings. Not all selections are available for each parameter.

SELECTION	DESCRIPTION
LOC	Not viewed on display line
<i>d-rEd</i>	View in Main Display Loop. Cannot change or reset.
<i>d-ENt</i>	View and change (reset) in Main Display Loop
<i>P-rEd</i>	View in Parameter Display Loop. Cannot change or reset.
<i>P-ENt</i>	View and change (reset) in Parameter Display Loop
<i>Hi dE</i>	View and change in Hidden Parameter Display Loop

LINE 2 INPUT ACCESS



LOC *d-rEd* *d-ENt*

When configured for *d-ENt*, the Input value can be reset (tare) using a front keypad sequence. To reset (tare), push the **P** key while viewing the Input value on Line 2. The display will show *rEt* **NO**. Press the **F1** key to select **YES** and then press **P** key. The display will indicate *rESEt* and then advance to Parameter Display.

LINE 2 TOTAL ACCESS



LOC *d-rEd* *d-ENt*

When configured for *d-ENt*, the Total value can be reset using a front keypad sequence. To reset, push the **P** key while viewing the Total value on Line 2. The display will show *r-tot* **NO**. Press the **F1** key to select **YES** and then press **P** key. The display will indicate *rESEt* and then advance to Parameter Display.

LINE 2 MAX ACCESS

Hi
LOC Ln2

LOC d-rEd d-ENt

When configured for *d-ENt*, the Max Display value can be reset using a front keypad sequence. To reset, push the **P** key while viewing the Hi value on Line 2. The display will show *r-Hi* *00*. Press the **F1** key to select *YES* and then press **P** key. The display will indicate *rESEt* and then advance to Parameter Display.

LINE 2 MIN ACCESS

Lo
LOC Ln2

LOC d-rEd d-ENt

When configured for *d-ENt*, the Min Display value can be reset using a front keypad sequence. To reset, push the **P** key while viewing the Lo value on Line 2. The display will show *r-Lo* *00*. Press the **F1** key to select *YES* and then press **P** key. The display will indicate *rESEt* and then advance to Parameter Display.

LINE 2 PARAMETER LIST A/B ACCESS

LiSt
LOC Ln2

LOC d-rEd d-ENt
P-rEd P-ENt H idE

When configured for *d-ENt*, the Parameter list can be selected using a front keypad sequence. To select, push the **P** key while viewing *LiSt* *x*. “x” will begin to flash, press the **F1** key to select “A” or “B” and then press **P** key. The selected Parameter List will become active and the display will advance to Parameter Display. See User Functions “Select Parameter List” for a description of the list function. The Line 2 Parameter List provides a means of setting or viewing the active parameter list.

LINE 2 SETPOINTS ACCESS

Sn
LOC Ln2

LOC d-rEd d-ENt
P-rEd P-ENt H idE

When configured for *d-ENt*, the **P** key must be pressed to select the item for change before the **F1** and **F2** keys will increment or decrement the value.

LINE 2 BAND/DEVIATION ACCESS

bn-dn
LOC Ln2

LOC d-rEd d-ENt
P-rEd P-ENt H idE

When configured for *d-ENt*, the **P** key must be pressed to select the item for change before the **F1** and **F2** keys will increment or decrement the value.

LINE 1 DISPLAY COLOR ACCESS

Color
LOC Ln2

LOC P-rEd P-ENt H idE

When configured for *P-ENt*, Line 1 Color can be selected in the Parameter Display by using the **F1** and **F2** keys while viewing *Color*.

DISPLAY INTENSITY ACCESS

d-LEU
LOC Ln2

LOC P-rEd P-ENt H idE

When configured for *P-ENt*, the display intensity can be selected in the Parameter Display by using the **F1** and **F2** keys while viewing *d-LEU*.

DISPLAY CONTRAST ACCESS

d-Cont
LOC Ln2

LOC P-rEd P-ENt H idE

When configured for *P-ENt*, the display contrast can be selected in the

Parameter Display by using the **F1** and **F2** keys while viewing *d-Cont*.

LINE 2 USER FUNCTIONS ACCESSIBLE ITEMS

FUNC
NO Ln2

YES NO

Select *YES* to display the following list of User functions that can be made available at the end of the Parameter (*P-ENt*) or Hidden (*H idE*) display loops. The more critical and frequently used Functions should be first assigned to the User Inputs and User Function keys. If more functions are needed than what can be obtained with User Inputs, this feature will provide a means to provide that access. Refer to module 2, *2-FUNCt* for a description of the function.

rEL bAt r-tot r-Hi r-Lo
r-HL r-1 r-2 r-3 r-4
r-34 r-234 r-ALL Pr int

PROGRAMMING SECURITY CODE

Code
0 dSP

000 to 250

To activate either the Parameter or Hidden Parameter Display Loops, a security code (1-250) must be entered. If a “0” security code is programmed, pressing the **P** key takes you directly to the Full Programming Mode.

The Security Code determines the programming mode and the accessibility of programming parameters. This code can be used along with the Program Mode Lock-out (*PLoC*) in the User Input Function parameter (Module 2).

Two programming modes are available. Full Programming Mode allows all parameters to be viewed and modified. Parameter Display Loop mode provides access to those selected parameters, that can be viewed and/or modified without entering the Full programming mode.

The following chart indicates the levels of access based on various *LoDE* and User Input *PLoC* settings.

SECURITY CODE	USER INPUT CONFIGURED	USER INPUT STATE	WHEN P KEY IS PRESSED	FULL PROGRAMMING MODE ACCESS
0	not <i>PLoC</i>	—	Full Programming	Immediate Access
>0	not <i>PLoC</i>	—	Enter Parameter Display Loop	After Parameter Display Loop with correct code # at <i>LoDE</i> prompt.
>0	<i>PLoC</i>	Active	Enter Parameter Display Loop	After Parameter Display Loop with correct code # at <i>LoDE</i> prompt.
>0	<i>PLoC</i>	Not Active	Full Programming	Immediate Access
0	<i>PLoC</i>	Active	Enter Parameter Display Loop	No Access
0	<i>PLoC</i>	Not Active	Full Programming	Immediate Access

MODULE 4 - SECONDARY FUNCTION PARAMETERS (4-5[ndry])

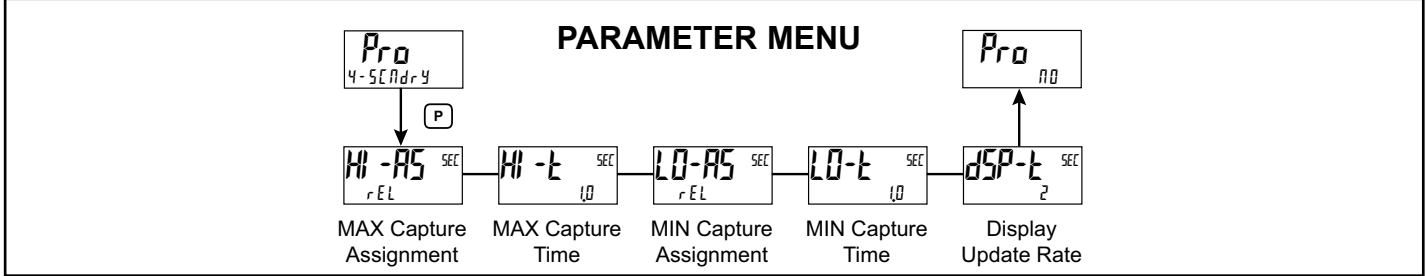

MAX CAPTURE ASSIGNMENT

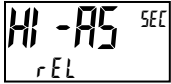

rEL Ab5

Select the desired parameter that will be assigned to the Max Capture.

MAX CAPTURE DELAY TIME

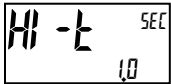

0.0 to 3275.0 seconds

When the Input Display is above the present MAX value for the entered delay time, the unit will capture that display value as the new MAX reading. A delay time helps to avoid false captures of sudden short spikes.

MIN CAPTURE ASSIGNMENT



rEL Ab5

Select the desired parameter that will be assigned to the Min Capture.

MIN CAPTURE TIME

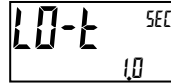

0.0 to 3275.0 seconds

When the Input Display is below the present MIN value for the entered delay time, the unit will capture that display value as the new MIN reading. A delay time helps to avoid false captures of sudden short spikes.

DISPLAY UPDATE RATE

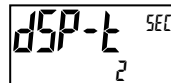

1 2 5 10 20 updates/second

This parameter configures the display update rate. It does not affect the response time of the setpoint output or analog output option cards.

MODULE 5 - TOTALIZER (INTEGRATOR) PARAMETERS (5-totAl)

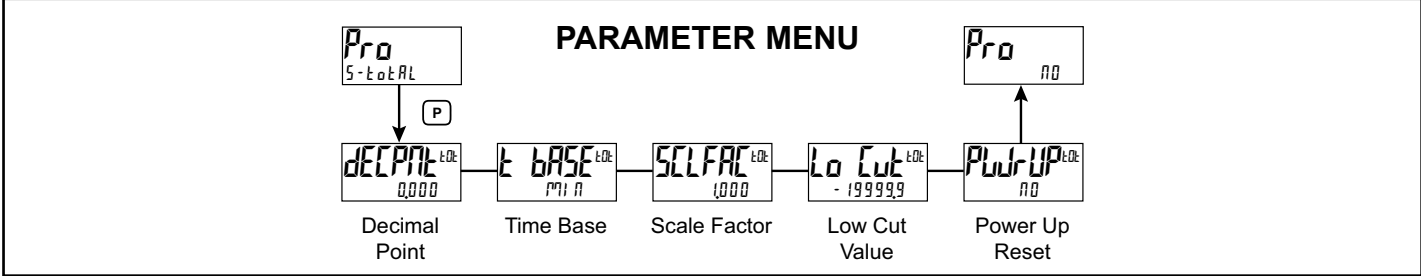

The totalizer accumulates (integrates) the Input Display value using one of two modes. The first is using a time base. This can be used to compute a time temperature product. The second is through a user input or function key programmed for Batch (one time add on demand). This can be used to provide a readout of temperature integration, useful in curing and sterilization applications. If the Totalizer is not needed, its display can be locked-out and this module can be skipped during programming.

TOTALIZER DECIMAL POINT

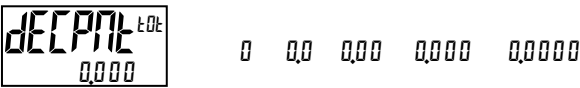

For most applications, this matches the Input Display Decimal Point (dEEPtL). If a different location is desired, refer to Totalizer Scale Factor.

TOTALIZER TIME BASE

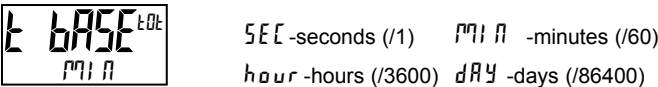

This is the time base used in Totalizer accumulations. If the Totalizer is being accumulated through a user input programmed for Batch, then this parameter does not apply.

TOTALIZER SCALE FACTOR



For most applications, the Totalizer reflects the same decimal point location and engineering units as the Input Display. In this case, the Totalizer Scale Factor is 1.000. The Totalizer Scale Factor can be used to scale the Totalizer to a value that is different than the Input Display. Common possibilities are:

1. Changing decimal point location (example tenths to whole)
2. Average over a controlled time frame.

Details on calculating the scale factor are shown later.

If the Totalizer is being accumulated through a user input programmed for Batch, then this parameter does not apply.

TOTALIZER LOW CUT VALUE

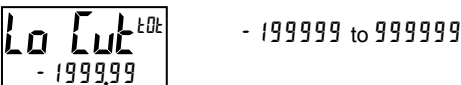

A low cut value disables Totalizer when the Input Display value falls below the value programmed.

TOTALIZER POWER UP RESET

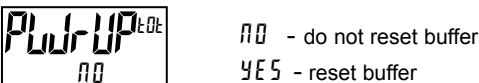

The Totalizer can be reset to zero on each unit power-up by setting this parameter to 4E5.

TOTALIZER BATCHING

The Totalizer Time Base and scale factor are overridden when a user input or function key is programmed for store batch (bAt). In this mode, when the user input or function key is activated, the Input Display reading is one time added to the Totalizer (batch). The Totalizer retains a running sum of each batch operation until the Totalizer is reset. This is useful in weighing operations, when the value to be added is not based on time but after a filling event.

TOTALIZER USING TIME BASE

Totalizer accumulates as defined by:

$$\frac{\text{Input Display} \times \text{Totalizer Scale Factor}}{\text{Totalizer Time Base}}$$

Where:

Input Display - the present input reading

Totalizer Scale Factor - 0.001 to 65.000

Totalizer Time Base - (the division factor of tBASE)

Example: The input reading is at a constant rate of 10.0 gallons per minute. The Totalizer is used to determine how many gallons in tenths has flowed. Because the Input Display and Totalizer are both in tenths of gallons, the Totalizer Scale Factor is 1. With gallons per minute, the Totalizer Time Base is minutes (60). By placing these values in the equation, the Totalizer will accumulate every second as follows:

$$\frac{10.0 \times 1.000}{60} = 0.1667 \text{ gallon accumulates each second}$$

This results in:

10.0 gallons accumulates each minute

600.0 gallons accumulates each hour

TOTALIZER SCALE FACTOR CALCULATION EXAMPLES

1. When changing the Totalizer Decimal Point (dEEPtL) location from the Input Display Decimal Point (dEEPtL), the required Totalizer Scale Factor is multiplied by a power of ten.

Example:

Input (dEEPtL) = 0

Input (dEEPtL) = 0.0

Input (dEEPtL) = 0.00

Totalizer dEEPtL	Scale Factor
0.0	10
0	1
x10	0.1
x100	0.01
x1000	0.001

Totalizer dEEPtL	Scale Factor
0.00	10
0.0	1
0	0.1
x10	0.01
x100	0.001

Totalizer dEEPtL	Scale Factor
0.000	10
0.00	1
0.0	0.1
0	0.01
x10	0.001

2. To obtain an average reading within a controlled time frame, the selected Totalizer Time Base is divided by the given time period expressed in the same timing units.

Example: Average temperature per hour in a 4 hour period, the scale factor would be 0.250. To achieve a controlled time frame, connect an external timer to a user input programmed for r-tAt. The timer will control the start (reset) and the stopping (hold) of the totalizer.

MODULE 6 - SETPOINT OUTPUT PARAMETERS (6-SETPNT)

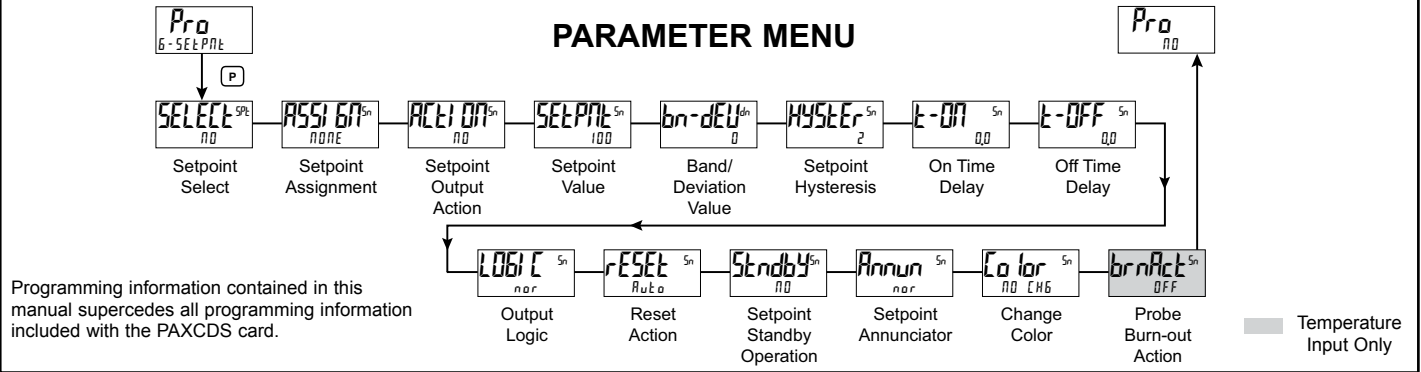

SETPOINT SELECT

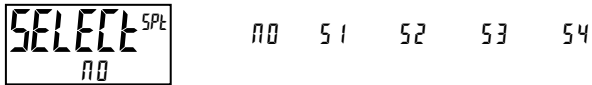

Enter the setpoint (alarm output) to be programmed. The “n” in the following parameters will reflect the chosen setpoint number. After the chosen setpoint is completely programmed, the display will return to *n0*. Repeat step for each setpoint to be programmed. The *n0* chosen at *SELECT^{SPT}*, will return to *Pro n0*. The number of setpoints available is setpoint output card dependent.

SETPOINT ASSIGNMENT



Selects the unit value to be used to trigger the Setpoint Alarm. The *rEL* setting will cause the setpoint to trigger off of the relative (net) input value. The relative input value is the absolute input value that includes the Display Offset Value. The *Abs* setting will cause the setpoint to trigger off of the absolute (gross) input value. The absolute input value is based on Module 1 *dSPLY* and *INPUT* entries.

SETPOINT ACTION

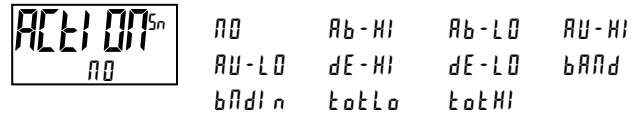

Enter the action for the selected setpoint (alarm output). See Setpoint Alarm Figures for a visual detail of each action. The Setpoint Actions that pertain to the total is only active when the Setpoint Assignment is set to *tAtAL*.

- n0* = No Setpoint Action
- Ab-HI* = Absolute high, with balanced hysteresis
- Ab-LO* = Absolute low, with balanced hysteresis
- AU-HI* = Absolute high, with unbalanced hysteresis
- AU-LO* = Absolute low, with unbalanced hysteresis
- dE-HI* = deviation high, with unbalanced hysteresis
- dE-LO* = deviation low, with unbalanced hysteresis
- bAND* = Outside band, with unbalanced hysteresis
- bAND n* = Inside band, with unbalanced hysteresis
- tAtLo* = Lower 6 digits of 9 digit Totalizer, with unbalanced hysteresis
- tAtHI* = Upper 6 digits of 9 digit Totalizer, with unbalanced hysteresis

Setpoint Alarm Figures

With reverse output logic *rEL*, the below alarm states are opposite.

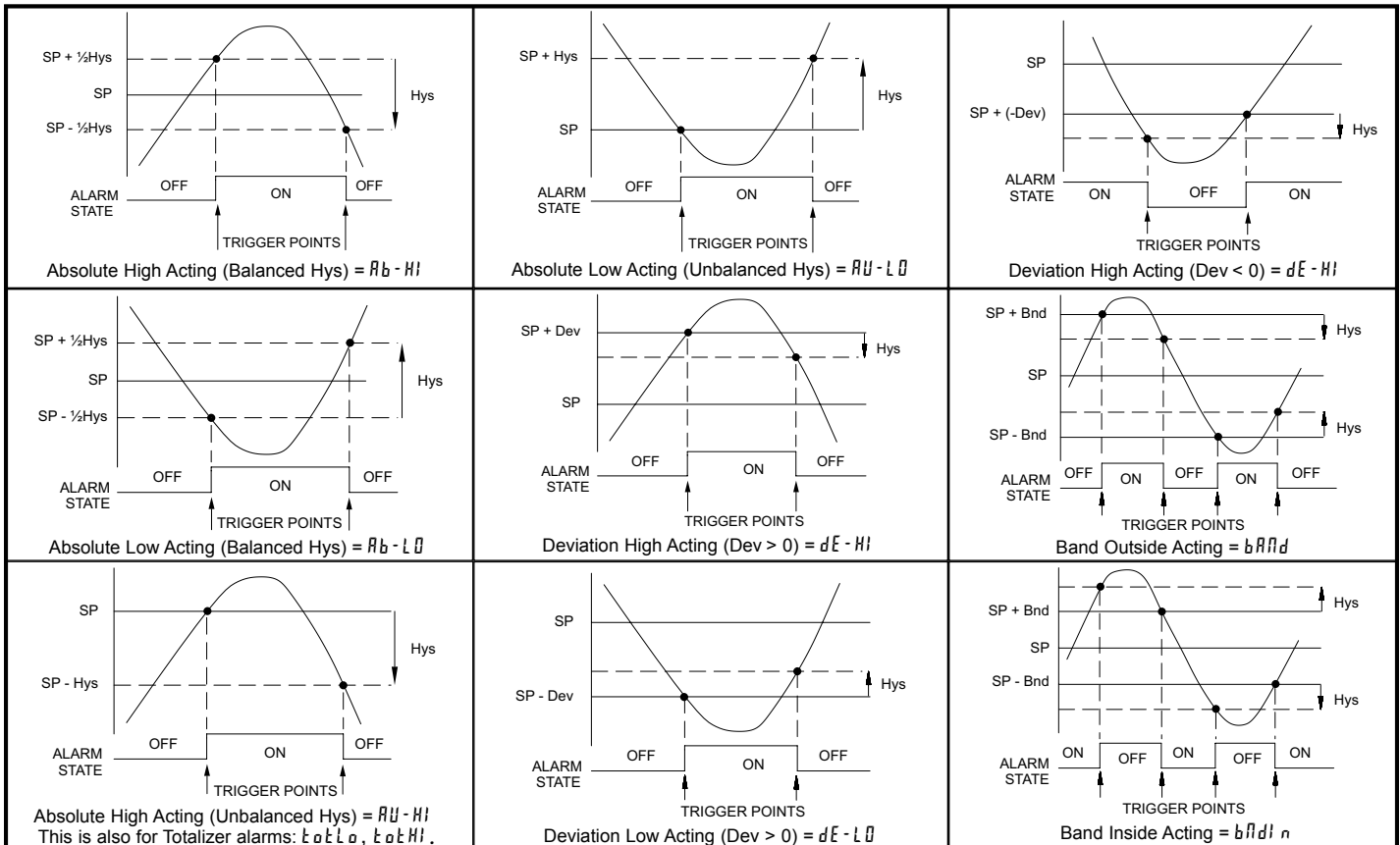

SETPOINT VALUE



- 199999 to 999999

Enter desired setpoint alarm value. Setpoint values can also be entered in the Display Mode during Program Lockout when the setpoint is programmed as *ELt* in Parameter Module 3. The decimal point position is determined by the Setpoint Assignment value.

BAND/DEVIATION VALUE



- 199999 to 999999

This parameter is only available in band and deviation setpoint actions. Enter desired setpoint band or deviation value. When the Setpoint Action is programmed for Band, this value can only be a positive value.

HYSTERESIS VALUE



1 to 65000

Enter desired hysteresis value. See Setpoint Alarm Figures for visual explanation of how setpoint alarm actions (balanced and unbalanced) are affected by the hysteresis. When the setpoint is a control output, usually balanced hysteresis is used. For alarm applications, usually unbalanced hysteresis is used. For unbalanced hysteresis modes, the hysteresis functions on the low side for high acting setpoints and functions on the high side for low acting setpoints. Note: Hysteresis eliminates output chatter at the switch point, while time delay can be used to prevent false triggering during process transient events.

ON TIME DELAY



00 to 32750 seconds

Enter the time value in seconds that the alarm is delayed from turning on after the trigger point is reached. A value of 0.0 allows the unit to update the alarm status per the response time listed in the Specifications. When the output logic is *rEu*, this becomes off time delay. Any time accumulated at power-off resets during power-up.

OFF TIME DELAY



00 to 32750 seconds

Enter the time value in seconds that the alarm is delayed from turning off after the trigger point is reached. A value of 0.0 allows the unit to update the alarm status per the response time listed in the Specifications. When the output logic is *rEu*, this becomes on time delay. Any time accumulated at power-off resets during power-up.

OUTPUT LOGIC



nor rEu

Enter the output logic of the alarm output. The *nor* logic leaves the output operation as normal. The *rEu* logic reverses the output logic. In *rEu*, the alarm states in the Setpoint Alarm Figures are reversed.

RESET ACTION



Aut0 LALch1 LALch2

Enter the reset action of the alarm output.

Aut0 = Automatic action; This action allows the alarm output to automatically reset off at the trigger points per the Setpoint Action shown in Setpoint Alarm Figures. The "on" alarm may be manually reset (off) immediately by a front panel function key or user input. The alarm remains reset off until the trigger point is crossed again.

LALch1 = Latch with immediate reset action; This action latches the alarm output on at the trigger point per the Setpoint Action shown in Setpoint Alarm

Figures. Latch means that the alarm output can only be turned off by front panel function key or user input manual reset, serial reset command or unit power cycle. When the user input or function key is activated (momentary or maintained), the corresponding "on" alarm output is reset immediately and remains off until the trigger point is crossed again. (Previously latched alarms will be off if power up Display Value is lower than setpoint value.)

LALch2 = Latch with delay reset action; This action latches the alarm output on at the trigger point per the Setpoint Action shown in Setpoint Alarm Figures. Latch means that the alarm output can only be turned off by front panel function key or user input manual reset, serial reset command or unit power cycle. When the user input or function key is activated (momentary or maintained), the unit delays the event until the corresponding "on" alarm output crosses the trigger off point. (Previously latched alarms are off if power up Display Value is lower than setpoint value. During a power cycle, the unit erases a previous Latch 2 reset if it is not activated at power up.)

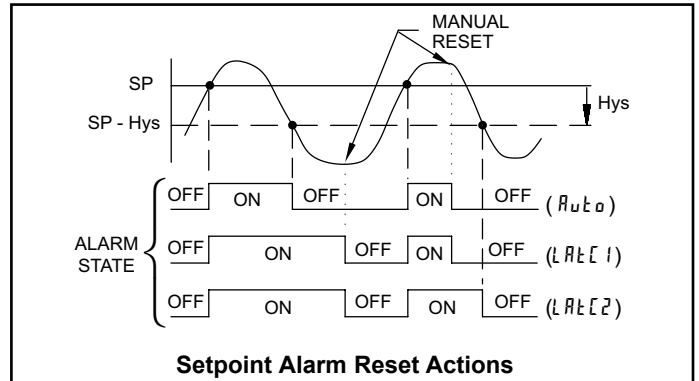

SETPOINT STANDBY OPERATION



no YES

When *YES*, the alarm is disabled (after a power up) until the trigger point is crossed. Once the alarm is on, the alarm operates normally per the Setpoint Action and Reset Mode.

SETPOINT ANNUNCIATOR



nor rEu FLASH OFF

The *OFF* mode disables display setpoint annunciators. The *nor* mode displays the corresponding setpoint annunciators of "on" alarm outputs. The *rEu* mode displays the corresponding setpoint annunciators of "off" alarms outputs. The *FLASH* mode flashes the corresponding setpoint annunciators of "on" alarm outputs.

LINE 1 CHANGE COLOR



no CH6 GREEN ORANGE red
GrnOr6 rEdOr6 rEdGrn LINE 1

This parameter allows the Line 1 Display to change color, or alternate between two colors, when the alarm is activated. When multiple alarms are programmed to change color, the highest numbered active alarm (S4-S1) determines the display color.

The *no CH6* selection will maintain the color displayed prior to the alarm activation. The *LINE 1* selection sets the display to the Line 1 Display Color (*Color*), programmed in Module 3.

The following programming step is only available when Input Range in Module 1 is set for a temperature input (TC/RTD).

PROBE BURN-OUT ACTION



OFF ON

Enter the probe burn-out action. In the event of a temperature probe failure (TC open; RTD open or short), the output can be programmed to be on or off.

MODULE 7 - SERIAL COMMUNICATIONS PARAMETERS (7-SERIAL)

PARAMETER MENU

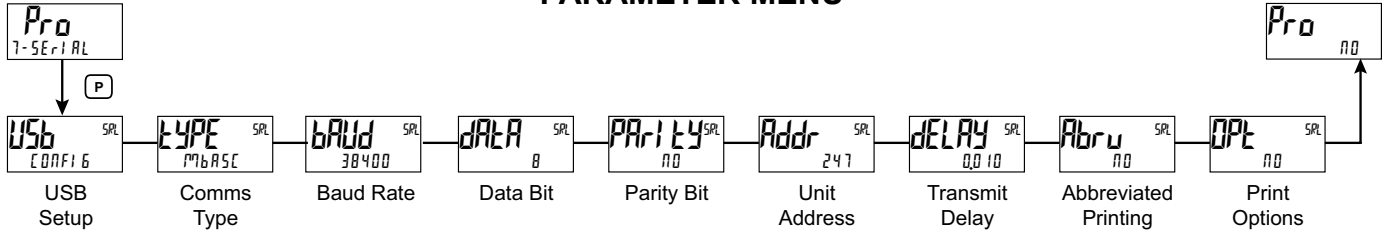

Programming information contained in this manual supercedes all programming information included with the PAXCDC card.

USB SETUP



CONF16 Port

CONF16 – Configures USB with settings required to operate with Crimson configuration software. This will automatically internally configure the PAX2A to use ModBus RTU protocol, 38400 baud, 8 bits, and unit address of 247 when a USB cable is attached to PAX2A and PC. The serial port settings shown in 7-SERIAL (this module) will not change, or show this.

Port – Configures USB to utilize serial settings and protocol as configured in “7-SERIAL” (this module).

COMMUNICATIONS TYPE



ModBus ASCII
RLC - RLC Protocol (ASCII)
ModBus RTU

Select the desired communications protocol. Modbus is preferred as it provides access to all unit values and parameters. Since the Modbus protocol is included within the PAX2A, the PAX Modbus option card, PAXCDC4, should not be used. The PAXCDC1 (RS485), or PAXCDC2 (RS232) card should be used instead.

BAUD RATE



1200 4800 19200
2400 9600 38400

Set the baud rate to match the other serial communications equipment on the serial link. Normally, the baud rate is set to the highest value that all the serial equipment are capable of transmitting and receiving.

DATA BIT

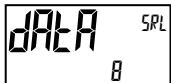

7 8

Select either 7 or 8 bit data word lengths. Set the word length to match the other serial communications equipment on the serial link.

PARITY BIT



NO EVEN Odd

Set the parity bit to match that of the other serial communications equipment on the serial link. The unit ignores the parity when receiving data and sets the parity bit for outgoing data. If no parity is selected with 7 bit word length, an additional stop bit is used to force the frame size to 10 bits.

UNIT ADDRESS

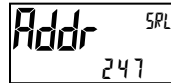

0 to 99 - RLC Protocol
1 to 247 - ModBus

Select a Unit Address that does not match an address number of any other equipment on the serial link.

TRANSMIT DELAY



0.000 to 0.250 seconds

Following a transmit value (“*” terminator) or Modbus command, the PAX2A will wait this minimum amount of time in seconds before issuing a serial response

The following programming steps are only available when Communications Type (TYPE) is programmed for RLC.

ABBREVIATED PRINTING



NO YES

Select YES for full print or Command T transmissions (unit address, mnemonics and parameter data) or NO for abbreviated print transmissions (parameter data only). This will affect all the parameters selected in the print options. If the unit address is 00, it will not be sent during a full transmission.

PRINT OPTIONS



NO YES

YES - Enters the sub-menu to select the unit parameters to appear during a print request. For each parameter in the sub-menu, select YES for that parameter information to be sent during a print request or NO for that parameter information not to be sent. A print request is sometimes referred to as a block print because more than one parameter information (unit address, mnemonics and parameter data) can be sent to a printer or computer as a block.

DISPLAY	DESCRIPTION	FACTORY SETTING	MNEMONIC
INP	Signal Input	YES	INP
TOT	Total Value	NO	TOT
MAX	Max & Min	NO	MAX, MIN
SP1	Setpoint Values	NO	SP1-SP4

SERIAL COMMUNICATIONS OVERVIEW

The PAX2 supports serial communications using the optional serial communication cards or via the USB programming port located on the side of the unit. When USB is being used (connected), the serial communication card is disabled. When using the standard RS232 and RS485 PAX option cards, the PAX2 supports both the RLC protocol and also supports ModBus communications. The PAX ModBus option card should not be used with the PAX2, as the PAX2 internal ModBus protocol supports complete unit configuration, and is much more responsive.

USB

The USB programming port is primarily intended to be used to configure the PAX2A with the Crimson programming software. It can also, be used as a virtual serial communications port following installation of the PAX2A USB drivers that are supplied with the Crimson software. When the USB port is being used, i.e. the USB cable is connected between PAX2A and PC, all serial communications with the serial option card (if used) is disabled.

USB Cable type required: USB A to Mini-B (not supplied)

PAX2A CONFIGURATION USING CRIMSON AND USB

1. Install Crimson software.
2. Supply power to PAX2A
3. Insure “USB” parameter in module *1-Serial*, is set to “*Factory 5*” (factory default setting).
4. Attach USB A – MiniB cable between PC and PAX2A
5. Create a new (File, New) or open an existing PAX2A database within Crimson.
6. Configure Crimson 2 Link, Options to the serial port the communication cable is attached (in Step 4).

SERIAL MODBUS COMMUNICATIONS

Modbus Communications requires that the Serial Communication Type Parameter (*TYPE*) be set to “*Modbus*” or “*Modbus*”.

PAX2A CONFIGURATION USING CRIMSON AND SERIAL COMMUNICATIONS CARD

1. Install Crimson software.
2. Install RS232 or RS485 card and connect communications cable from PAX2A to PC.
3. Supply power to PAX2A
4. Configure serial parameters in *1-Serial* to *Modbus*, 38,400 baud, address 247.
5. Create a new (File, New) or open an existing PAX2A database within Crimson.
6. Configure Crimson 2 Link, Options to the serial port the communication cable is attached (in step 2).

SUPPORTED FUNCTION CODES

FC03: Read Holding Registers

1. Up to 32 registers can be requested at one time.
2. HEX <8000> is returned for non-used registers.

FC04: Read Input Registers

1. Up to 32 registers can be requested at one time.
2. Block starting point can not exceed register boundaries.
3. HEX <8000> is returned in registers beyond the boundaries.
4. Input registers are a mirror of Holding registers.

FC06: Preset Single Register

1. HEX <8001> is echoed back when attempting to write to a read only register.
2. If the write value exceeds the register limit (see Register Table), then that register value changes to its high or low limit. It is also returned in the response.

FC16: Preset Multiple Registers

1. No response is given with an attempt to write to more than 32 registers at a time.
2. Block starting point cannot exceed the read and write boundaries (1-1280).
3. If a multiple write includes read only registers, then only the write registers will change.
4. If the write value exceeds the register limit (see Register Table), then that register value changes to its high or low limit.

FC08: Diagnostics

The following is sent upon FC08 request:

Module Address, 08 (FC code), 04 (byte count), “Total Comms” 2 byte count, “Total Good Comms” 2 byte count, checksum of the string
“Total Comms” is the total number of messages received that were addressed to the PAX2. “Total Good Comms” is the total messages received by the PAX2A with good address, parity and checksum. Both counters are reset to 0 upon response to FC08 and at power-up.

FC17: Report Slave ID

The following is sent upon FC17 request:

RLC-PAX2A ab<0100h><20h><20h><10h>
a = SP Card, “0”-No SP, “2” or “4” SP
b = Linear Card “0” = None, “1” = Yes
<0100> Software Version Number (1.00)
<20h>Max Register Reads (32)
<20h>Max Register Writes (32)
<10h> Number Guid/Scratch Pad Regs (16)

SUPPORTED EXCEPTION CODES

01: Illegal Function

Issued whenever the requested function is not implemented in the unit.

02: Illegal Data Address

Issued whenever an attempt is made to access a single register that does not exist (outside the implemented space) or to access a block of registers that falls completely outside the implemented space.

03: Illegal Data Value

Issued when an attempt is made to read or write more registers than the unit can handle in one request.

07: Negative Acknowledge

Issued when a write to a register is attempted with an invalid string length.

PAX2A FREQUENTLY USED MODBUS REGISTERS

Only frequently used registers are shown below. The entire Modbus Register Table can be found at www.redlion.net.

The following is an example of the necessary query and corresponding response for holding register 2. In this example register 2 is the decimal value 123.

Query: 01 03 00 01 00 01 D5 CA

Response: 01 03 02 00 7B F8 67

Notes:

1. The PAX registers can be read as holding (4x) or input (3x) registers.
2. For a value spanning two registers, the portion of the value less than 65,535 will be in (Lo word) register and the portion of the value greater than 65,535 will continue into (Hi word) register. Negative values are represented by two's complement of the combined (Hi word) and (Lo word).
3. The PAX2 should not be powered down while parameters are being changed. Doing so may result in an in-complete write to the non-volatile memory and produce checksum errors.

REGISTER (4x)	REGISTER NAME	LOW LIMIT	HIGH LIMIT	FACTORY SETTING	ACCESS	COMMENTS
1	Input Relative Value (Hi word)	N/A	N/A	N/A	Read Only	Process value of present input level. This value is affected by Input Type, Resolution, Scaling, & Offset Value. (Relative Value = Absolute Input Value + Offset Value)
2	Input Relative Value (Lo word)					
3	Maximum Value (Hi word)	-199999	999999	N/A	Read/Write	
4	Maximum Value (Lo word)					
5	Minimum Value (Hi word)	-199999	999999	N/A	Read/Write	
6	Minimum Value (Lo word)					
7	Total Value (Hi word)	-199999999	999999999	N/A	Read/Write	
8	Total Value (Lo word)					
9	Setpoint 1 Value (Hi word)	-199999	999999	100	Read/Write	Active List (A or B)
10	Setpoint 1 Value (Lo word)					
11	Setpoint 2 Value (Hi word)	-199999	999999	200	Read/Write	Active List (A or B)
12	Setpoint 2 Value (Lo word)					
13	Setpoint 3 Value (Hi word)	-199999	999999	300	Read/Write	Active List (A or B)
14	Setpoint 3 Value (Lo word)					
15	Setpoint 4 Value (Hi word)	-199999	999999	400	Read/Write	Active List (A or B)
16	Setpoint 4 Value (Lo word)					
17	Setpoint 1 Band/Dev. Value (Hi word)	-199999	999999	0	Read/Write	Active List (A or B). Applicable only for Band or Deviation Setpoint Action.
18	Setpoint 1 Band/Dev. Value (Lo word)					
19	Setpoint 2 Band/Dev. Value (Hi word)	-199999	999999	0	Read/Write	Active List (A or B). Applicable only for Band or Deviation Setpoint Action.
20	Setpoint 2 Band/Dev. Value (Lo word)					
21	Setpoint 3 Band/Dev. Value (Hi word)	-199999	999999	0	Read/Write	Active List (A or B). Applicable only for Band or Deviation Setpoint Action.
22	Setpoint 3 Band/Dev. Value (Lo word)					
23	Setpoint 4 Band/Dev. Value (Hi word)	-199999	999999	0	Read/Write	Active List (A or B). Applicable only for Band or Deviation Setpoint Action.
24	Setpoint 4 Band/Dev. Value (Lo word)					
25	Setpoint Output Register (SOR)	0	15	N/A	Read/Write	Status of Setpoint Outputs. Bit State: 0 = Off, 1 = On. Bit 3 = S1, Bit 2 = S2, Bit 1 = S3, Bit 0 = S4. Outputs can only be activated/reset with this register when the respective bits in the Manual Mode Register (MMR) are set.
26	Manual Mode Register (MMR)	0	31	0	Read/Write	Bit State: 0 = Auto Mode, 1 = Manual Mode Bit 4 = S1, Bit 3 = S2, Bit 2 = S3, Bit 1 = S4, Bit 0 = Linear Output
27	Reset Output Register	0	15	0	Read/Write	Bit State: 1 = Reset Output, bit is returned to zero following reset processing; Bit 3 = S1, Bit 2 = S2, Bit 1 = S3, Bit 0 = S4
28	Analog Output Register (AOR)	0	4095	0	Read/Write	Linear Output Card written to only if Linear Output is in Manual Mode. (MMR bit 0 = 1)
29	Input Absolute Value (Hi word)	N/A	N/A	N/A	Read Only	Gross value of present Input level. This value is affected by Input Type, Resolution, Scaling, but not affected by Offset Value
30	Input Absolute Value (Lo word)					
31	Input Offset Value (Hi word)	-199999	999999	0	Read/Write	Input Offset Value plus the Input Absolute Value equals the Relative Input Value (standard unit value).
32	Input Offset Value (Lo word)					

SERIAL RLC PROTOCOL COMMUNICATIONS

RLC Communications requires the Serial Communications Type Parameter (TYPE) be set to "rLL".

SENDING SERIAL COMMANDS AND DATA TO THE UNIT

When sending commands to the unit, a string containing at least one command character must be constructed. A command string consists of a command character, a value identifier, numerical data (if writing data to the unit) followed by a command terminator character * or \$.

Command Chart

COMMAND	DESCRIPTION	NOTES
N	Node (unit) Address Specifier	Address a specific unit. Must be followed by a one or two digit node address. Not required when address = 0.
T	Transmit Value (read)	Read a register from the unit. Must be followed by register ID character
V	Value Change (write)	Write to register or output. Must be followed by register ID character and numeric data.
R	Reset	Reset a register or output. Must be followed by register ID character.
P	Block Print Request	Initiates a block print output. Registers are defined in programming.

Command String Construction

The command string must be constructed in a specific sequence. The unit does not respond with an error message to invalid commands. The following procedure details construction of a command string:

1. The first characters consist of the Node Address Specifier (N) followed by a 1 or 2 character address number. The address number of the unit is programmable. If the node address is 0, this command and the node address itself may be omitted. This is the only command that may be used in conjunction with other commands.
2. After the address specifier, the next character is the command character.
3. The next character is the Register ID. This identifies the register that the command affects. The P command does not require a Register ID character. It prints according to the selections made in print options.
4. If constructing a value change command (writing data), the numeric data is sent next.
5. All command strings must be terminated with the string termination characters * or \$. The unit does not begin processing the command string until this character is received. See Timing Diagram figure for differences between terminating characters.

Register Identification Chart

ID	VALUE DESCRIPTION	MNEMONIC	APPLICABLE COMMANDS/COMMENTS
A	Input (relative value)	INP	T, P, R (Reset command resets input to zero; tares)
B	Total	TOT	T, P, R (Reset command resets total to zero)
C	Max Input	MAX	T, P, R (Reset command resets Max to current reading)
D	Min Input	MIN	T, P, R (Reset command resets Min to current reading)
E	Setpoint 1	SP1	T, P, V, R (Reset command resets the setpoint output)
F	Setpoint 2	SP2	
G	Setpoint 3	SP3	
H	Setpoint 4	SP4	
I	Band/Deviation 1	BD1	T, V
J	Band/Deviation 2	BD2	T, V
K	Band/Deviation 3	BD3	T, V
L	Band/Deviation 4	BD4	T, V
M	Absolute Input value	ABS	T
O	Offset	OFS	T, V
U	Auto/Manual Register	MMR	T, V
W	Analog Output Register	AOR	T, V
X	Setpoint Register	SOR	T, V

Command String Examples:

1. Node address = 17, Write 350 to Setpoint 1.
String: N17VE350\$
2. Node address = 5, Read Input value.
String: N5TA*
3. Node address = 0, Reset Setpoint 4 output.
String: RH*

Sending Numeric Data

Numeric data sent to the unit must be limited to 6 digits (-199999 to 999999). Leading zeros are ignored. Negative numbers must have a minus sign. The unit ignores any decimal point and conforms the number to the scaled resolution. (For example: the unit's scaled decimal point position = 0.0 and 25 is written to a register. The value of the register is now 2.5).

Note: Since the unit does not issue a reply to value change commands, follow with a transmit value command for readback verification.

RECEIVING DATA FROM THE UNIT

Data is transmitted by the unit in response to either a transmit command (T), a print block command (P) or User Function print request. The response from the unit is either a full field transmission or an abbreviated transmission. The unit response mode is selected in program Module 7 (*Rbru*).

Full Field Transmission (Address, Mnemonic, Numeric data)

Byte	Description
1, 2	2 byte Node Address field [00-99]
3	<SP> (Space)
4-6	3 byte Register Mnemonic field
7-18	2 byte data field, 10 bytes for number, one byte for sign, one byte for decimal point
19	<CR> carriage return
20	<LF> line feed
21	<SP>* (Space)
22	<CR>* carriage return
23	<LF>* line feed

* These characters only appear in the last line of a block print.

The first two characters transmitted are the node address, unless the node address assigned = 0, in which case spaces are substituted. A space follows the node address field. The next three characters are the register mnemonic.

The numeric data is transmitted next. The numeric field is 12 characters long (to accommodate the 10 digit totalizer), with the decimal point position floating within the data field. Negative values have a leading minus sign. The data field is right justified with leading spaces.

The end of the response string is terminated with a carriage return <CR> and <LF>. When block print is finished, an extra <SP><CR> <LF> is used to provide separation between the blocks.

Abbreviated Transmission (Numeric data only)

Byte	Description
1-12	12 byte data field, 10 bytes for number, one byte for sign, one byte for decimal point
13	<CR> carriage return
14	<LF> line feed
15	<SP>* (Space)
16	<CR>* carriage return
17	<LF>* line feed

* These characters only appear in the last line of a block print.

Unit Response Examples:

- Node address = 17, full field response, Input = 875
17 INP 875 <CR><LF>
- Node address = 0, full field response, Setpoint 2 = -250.5
SP2 -250.5<CR><LF>
- Node address = 0, abbreviated response, Setpoint 2 = 250, last line of block print
250<CR><LF><SP><CR><LF>

Auto/Manual Mode Register (MMR) ID: U

This register sets the controlling mode for the outputs. In Auto Mode (0) the unit controls the setpoint and analog output. In Manual Mode (1) the outputs are defined by the registers SOR and AOR. When transferring from auto mode to manual mode, the unit holds the last output value (until the register is changed by a write). Each output may be independently changed to auto or manual. In a write command string (VU), any character besides 0 or 1 in a field will not change the corresponding output mode.

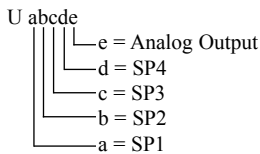

Example: VU00011 places SP4 and Analog in manual.

Analog Output Register (AOR) ID: W

This register stores the present signal value of the analog output. The range of values of this register is 0 to 4095, which corresponds to the analog output range per the following chart:

Register Value	Output Signal*		
	0-20 mA	4-20 mA	0-10 V
0	0.00	4.00	0.000
1	0.005	4.004	0.0025
2047	10.000	12.000	5.000
4094	19.995	19.996	9.9975
4095	20.000	20.000	10.000

*Due to the absolute accuracy rating and resolution of the output card, the actual output signal may differ 0.15% FS from the table values. The output signal corresponds to the range selected (0-20 mA, 4-20 mA or 0-10 V).

Writing to this register (VW) while the analog output is in the Manual Mode causes the output signal level to update immediately to the value sent. While in the Automatic Mode, this register may be written to, but it has no effect until the analog output is placed in the manual mode. When in the Automatic Mode, the unit controls the analog output signal level. Reading from this register (TW) will show the present value of the analog output signal.

Example: VW2047 will result in an output of 10.000 mA, 12.000 mA or 5.000V depending on the range selected.

Setpoint Output Register (SOR) ID: X

This register stores the states of the setpoint outputs. Reading from this register (TX) will show the present state of all the setpoint outputs. A "0" in the setpoint location means the output is off and a "1" means the output is on.

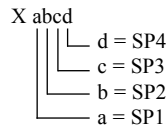

In Automatic Mode, the unit controls the setpoint output state. In Manual Mode, writing to this register (VX) will change the output state. Sending any character besides 0 or 1 in a field or if the corresponding output was not first in manual mode, the corresponding output value will not change. (It is not necessary to send least significant 0s.)

Example: VX10 will result in output 1 on and output 2 off.

COMMAND RESPONSE TIME

The unit can only receive data or transmit data at any one time (half-duplex operation). When sending commands and data to the unit, a delay must be imposed before sending another command. This allows enough time for the unit to process the command and prepare for the next command.

At the start of the time interval t_1 , the computer program prints or writes the string to the com port, thus initiating a transmission. During t_1 , the command characters are under transmission and at the end of this period, the command terminating character (*) is received by the unit. The time duration of t_1 is dependent on the number of characters and baud rate of the channel.

$$t_1 = (10 * \# \text{ of characters}) / \text{baud rate}$$

At the start of time interval t_2 , the unit starts the interpretation of the command and when complete, performs the command function. This time interval t_2 varies from 2 msec to 15 msec. If no response from the unit is expected, the unit is ready to accept another command.

If the unit is to reply with data, the time interval t_2 is controlled by the use of the command terminating character and the (Serial Transmit Delay parameter ($dELAY$)). The standard command line terminating character is “*”. This terminating character results in a response time window of the Serial Transmit Delay time ($dELAY$) plus 15 msec. maximum. The $dELAY$ parameter should be programmed to a value that allows sufficient time for the release of the sending driver on the RS485 bus. Terminating the command line with “\$” results in a response time window (t_2) of 2 msec minimum and 15 msec maximum. The response time of this terminating character requires that sending drivers release within 2 msec after the terminating character is received.

At the beginning of time interval t_3 , the unit responds with the first character of the reply. As with t_1 , the time duration of t_3 is dependent on the number of characters and baud rate of the channel.

$$t_3 = (10 * \# \text{ of characters}) / \text{baud rate}$$

At the end of t_3 , the unit is ready to receive the next command. The maximum serial throughput of the unit is limited to the sum of the times t_1 , t_2 and t_3 .

Timing Diagrams

NO REPLY FROM UNIT

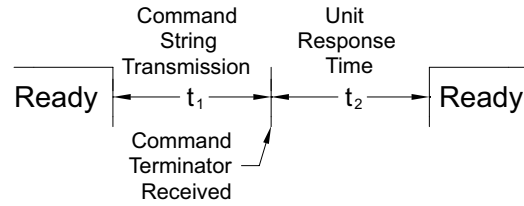

RESPONSE FROM UNIT

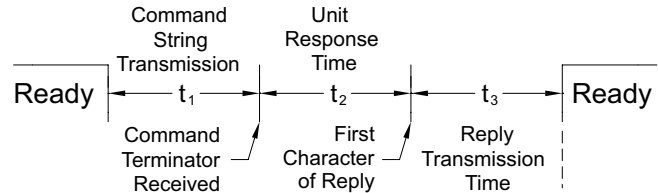

COMMUNICATION FORMAT

Data is transferred from the unit through a serial communication channel. In serial communications, the voltage is switched between a high and low level at a predetermined rate (baud rate) using ASCII encoding. The receiving device reads the voltage levels at the same intervals and then translates the switched levels back to a character.

The voltage level conventions depend on the interface standard. The table lists the voltage levels for each standard.

LOGIC	INTERFACE STATE	RS232*	RS485*
1	mark (idle)	TXD,RXD; -3 to -15 V	a-b < -200 mV
0	space (active)	TXD,RXD; +3 to +15 V	a-b > +200 mV

* Voltage levels at the Receiver

Data is transmitted one byte at a time with a variable idle period between characters (0 to ∞). Each ASCII character is “framed” with a beginning start bit, an optional parity bit and one or more ending stop bits. The data format and baud rate must match that of other equipment in order for communication to take place. The figures list the data formats employed by the unit.

Start bit and Data bits

Data transmission always begins with the start bit. The start bit signals the receiving device to prepare for reception of data. One bit period later, the least significant bit of the ASCII encoded character is transmitted, followed by the remaining data bits. The receiving device then reads each bit position as they are transmitted. Since the sending and receiving devices operate at the same transmission speed (baud rate), the data is read without timing errors.

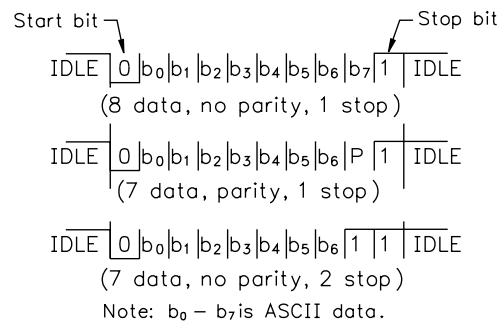

Character Frame Figure

Parity bit

After the data bits, the parity bit is sent. The transmitter sets the parity bit to a zero or a one, so that the total number of ones contained in the transmission (including the parity bit) is either even or odd. This bit is used by the receiver to detect errors that may occur to an odd number of bits in the transmission. However, a single parity bit cannot detect errors that may occur to an even number of bits. Given this limitation, the parity bit is often ignored by the receiving device. The PAX ignores the parity bit of incoming data and sets the parity bit to odd, even or none (mark parity) for outgoing data.

Stop bit

The last character transmitted is the stop bit. The stop bit provides a single bit period pause to allow the receiver to prepare to re-synchronize to the start of a new transmission (start bit of next byte). The receiver then continuously looks for the occurrence of the start bit. If 7 data bits and no parity is selected, then 2 stop bits are sent from the PAX.

MODULE 8 - ANALOG OUTPUT PARAMETERS (8-ANL Out)

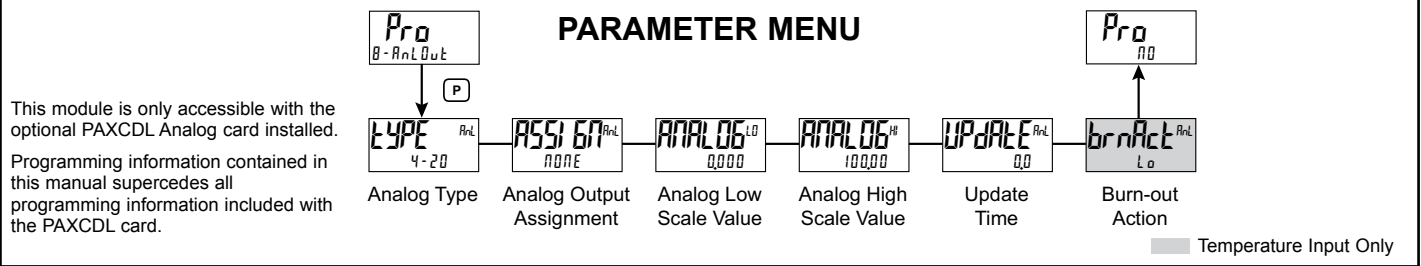

ANALOG OUTPUT TYPE



4-20 0-10 0-20

Enter the analog output type. For 0-20 mA or 4-20 mA use terminals 18 and 19. For 0-10 V use terminals 16 and 17. Only one range can be used at a time.

ANALOG OUTPUT ASSIGNMENT



NONE rEL Abs tOTAL Hi Lo
51 52 53 54

Enter the source for the analog output to retransmit:

- NONE = Manual Mode operation. (See Module 7, Serial RLC Protocol).
- rEL = Relative (net) Input Value. The Relative Input Value is the Absolute Input Value including the Display Offset Value.
- Abs = Absolute (gross) Input Value. The Absolute Input Value is the scaled input value. It does not include the Display Offset Value.
- tOTAL = Totalizer Value
- Hi = Maximum Display Value
- Lo = Minimum Display Value
- 51-54 = Setpoint Values

ANALOG LOW SCALE VALUE



- 199999 to 999999

Enter the Display Value that corresponds to 0 mA (0-20 mA) , 4 mA (4-20 mA) or 0 VDC (0-10 VDC).

ANALOG HIGH SCALE VALUE



- 199999 to 999999

Enter the Display Value that corresponds to 20 mA (0-20 mA) , 20 mA (4-20 mA) or 10 VDC (0-10 VDC).

ANALOG UPDATE TIME



0.0 to 10.0

Enter the analog output update rate in seconds. A value of 0.0 allows the unit to update the analog output at the ADC Conversion Rate.

The following programming step is only available when Input Range in Module 1 is set for a temperature input (TC/RTD).

PROBE BURN-OUT ACTION



Hi Lo

Enter the probe burn-out action. In the event of a temperature probe failure, the analog output can be programmed for low or high scale.

MODULE 9 - FACTORY SERVICE OPERATIONS (9-FACTry)

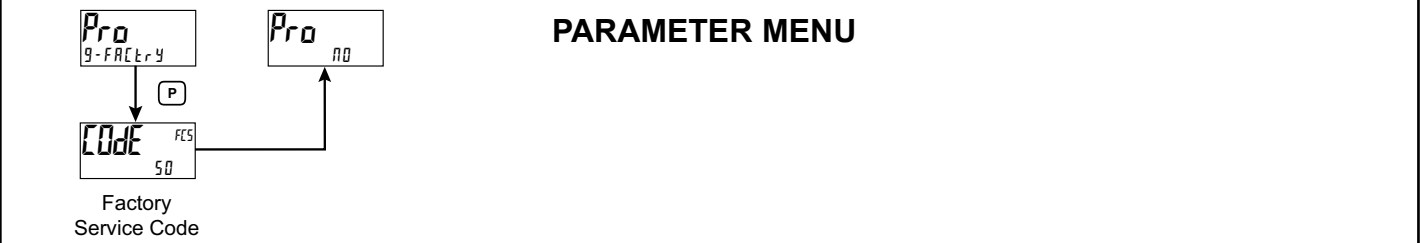

RESTORE FACTORY DEFAULTS

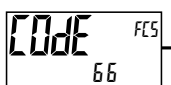

Use the **F1** and **F2** keys to display **CODE 66** and press **P**. The unit will flash **rESEt** and then return to **CODE 50**. Press the **P** key to return to Display Mode. This will overwrite all user settings with the factory settings.

CALIBRATION

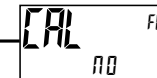

00 Curr Volt
0h7m5 tc ICE
rtd AnLOut

The unit has been fully calibrated at the factory. Scaling to convert the input signal to a desired display value is performed in Module 1. If the unit appears to be indicating incorrectly or inaccurately, refer to Troubleshooting before attempting to calibrate the unit. When recalibration is required (generally every 2 years), it should only be performed by qualified technicians using appropriate equipment. Calibration does not change any user programmed parameters. However, it will affect the accuracy of the input signal and the values previously stored using the Apply (APPLY) Scaling Style.

MODEL AND CODE VERSION

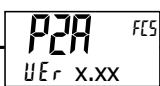
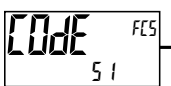

The unit will briefly display the model (**P2R**) on Line 1, and the current firmware version (**UER x.xx**) on Line 2, and then return to **CODE 50**.

Preparation for Current, Volt, and Ohm Input Calibration



Warning: Input Calibration requires a signal source capable of producing a signal greater than or equal to the range being calibrated with an accuracy of 0.01% or better.

Before starting, verify that the Input Range, T/V, and Excitation Jumper is set for the range to be calibrated. Verify that the precision signal source is connected and ready. Allow a 30 minute warm-up period before calibrating the unit. Selecting \overline{R} at any calibration step, will cause the unit to maintain the existing calibration parameters for that step. Selecting $\overline{Y E 5}$ and pressing the **P** key will cause the unit to store new calibration settings for the range selected. Pressing **D** at any time will exit programming mode, but any range that has been calibrated will maintain the new settings.

Current, Volt and Ohm Calibration Procedure

1. After entering $\overline{C a d E} \ 4 \overline{B}$, in Module 9, select the input signal type ($\overline{C u r r}$, $\overline{V o l t}$, $\overline{O h m s}$) to be calibrated.
2. Press the **P** key until the desired range along with $\overline{Z E P}$ is indicated on Line 1 of the unit.
3. Apply the zero input limit of the range indicated on Line 1 of the unit.
4. Press $\overline{F 1}$ to select $\overline{Y E 5}$.
5. Press **P**. Display will indicate - - - - on Line 2 as the unit reads and stores the new calibration parameter.
6. Display will indicate the desired range along with $\overline{F u l l}$ on Line 1 of the unit.
7. Apply the signal level indicated on Line 1 of the unit.
8. Press $\overline{F 1}$ to select $\overline{Y E 5}$.
9. Press **P**. Display will indicate - - - - on Line 2 as the unit reads and stores the new calibration parameter.
10. Repeat Preparation and Calibration Procedure for each Input Range to be calibrated.

Preparation for TC calibration

TC calibration parameters will affect RTD calibration. If using an RTD, it is recommended that the RTD calibration be performed after completing the TC calibration.



Warning: TC Input Calibration requires a signal source capable of producing a 60 mV signal with an accuracy of 0.01% or better.

Before starting, verify the T/V jumper is in the T position. Verify the precision signal source is connected and ready. Allow a 30 minute warm-up period before calibrating the unit. Selecting \overline{R} at any calibration step, will cause the unit to maintain the existing calibration parameters for that step. Selecting $\overline{Y E 5}$ and pressing **P** key will cause the unit to store new calibration settings for the range selected. Pressing **D** at any time will exit programming mode, but any range that has been calibrated will maintain the new settings.

TC Calibration Procedure

1. After entering $\overline{C a d E} \ 4 \overline{B}$, in Module 9, select the $\overline{T c}$.
2. Press the **P** key. Display will indicate $\overline{0.0000}$ with $\overline{Z E P}$ in upper right.
3. Apply 0 mV to input.
4. Press $\overline{F 1}$ to select $\overline{Y E 5}$.
5. Press **P**. Display will indicate - - - - on Line 2 as the unit reads and stores the new calibration parameter.
6. Display will indicate $\overline{0.0600}$ with $\overline{F u l l}$ in upper right.
7. Apply 60 mV to input.
8. Press $\overline{F 1}$ to select $\overline{Y E 5}$.
9. Press **P**. Display will indicate - - - - on Line 2 as the unit reads and stores the new calibration parameter.
10. TC Calibration complete.

Preparation for RTD Input Calibration

RTD calibration is dependent on TC calibration parameters. Therefore, the TC calibration should be performed prior to attempting the RTD calibration.



Warning: RTD Input Calibration requires a signal source capable of producing a 300 ohm resistance with an accuracy of 0.01% or better.

Before starting, verify that the T/V Jumper is in the T position. Verify the RTD jumper is in the proper range. Verify the precision signal source is connected and ready. Allow a 30 minute warm-up period before calibrating the unit. Selecting \overline{R} at any calibration step, will cause the unit to maintain the existing calibration parameters for that step. Selecting $\overline{Y E 5}$ and pressing **P** key will cause the unit to store new calibration settings for the range selected. Pressing **D** at any time will exit programming mode, but any range that has been calibrated will maintain the new settings.

RTD Calibration Procedure

1. After entering Code 48, in Module 9, select $\overline{r t d}$.
2. Press the **P** key until the desired range along with \overline{R} in upper right corner is indicated on Line 1 of the unit.
3. Apply zero ohms to the input of the unit.
4. Press $\overline{F 1}$ to select $\overline{Y E 5}$.
5. Press **P**. Display will indicate - - - - on Line 2 as the unit reads and stores the new calibration parameter.
6. Display will indicate the desired range along with a value in the upper right corner, in ohms, to be applied in the next step on Line 1 of the unit.
7. Apply the signal level, in ohms, indicated in the upper right corner of Line 1 on the unit.
8. Press $\overline{F 1}$ to select $\overline{Y E 5}$.
9. Press **P**. Display will indicate - - - - on Line 2 as the unit reads and stores the new calibration parameter.
10. Repeat Preparation and Calibration Procedure for each Input Range to be calibrated.

Ice Point Calibration Procedure

1. Remove all option cards.
2. Verify ambient temperature of unit environment is between 20°C and 30°C.
3. Set T/V jumper in the T position.
4. Connect a thermocouple with an accuracy of 1°C or better to the unit.
5. In Module 1 of unit programming, verify Input Range ($\overline{r a n g e}$) is set to the type thermocouple connected in step 4, Temperature Scale ($\overline{s c a l e}$) is °C, Ice Point Compensation ($\overline{i l e}$) is turned ON, Decimal Resolution ($\overline{d e c r e s}$) is 0.0, Rounding Increment ($\overline{r o u n d}$) is 0.1 and Display Offset ($\overline{o f f s e t}$) is set to 0.
6. Place the thermocouple in close thermal contact to a reference thermometer probe. (Use a reference thermometer with an accuracy of 0.25% °C or better.) The two probes should be shielded from air movement and allowed sufficient time to equalize in temperature. (A calibration bath could be used in place of the thermometer.)
7. If a difference exists between PAX2A display and reference thermometer, continue calibration.
8. Note the PAX2A display reading as the “Display Mode” reading to be used in Step 12.
9. Enter Module 9, select $\overline{C a d E} \ 4 \overline{B}$ and press **P**.
10. Select $\overline{i l e}$ and press **P**.
11. Display will indicate the Existing ICE Point Value.
12. Calculate a new ICE Point Value using: Existing ICE Point Value + (reference temperature – Display Mode reading). All values are in °C.
13. Using $\overline{F 1}$ and $\overline{V 2}$ change Existing ICE Point Value to indicate the new ICE Point Value calculated in Step 12.
14. Press **P** and return to Display Mode. Verify the Display Mode reading (with 0 Display Offset) matches the reference temperature. If not, repeat steps 8 thru 14.

Preparation for Analog Output Card Calibration



Warning: Calibration requires an external meter with an accuracy of 0.005% or better.

Before starting, verify that the precision voltmeter (voltage output) or current meter (current output) is connected and ready. Perform the following procedure.

1. After entering $\overline{C a d E} \ 4 \overline{B}$, in Module 9, select $\overline{A n l O u t}$.
2. Using the chart below, step through the five selections to be calibrated. At each prompt, use the PAX2A $\overline{F 1}$ and $\overline{V 2}$ keys to adjust the external meter display to match the selection being calibrated. When the external reading matches, or if the particular range is not in need of calibration, press the **P** key to advance to the next range.

PAX2A DISPLAY	EXTERNAL METER	ACTION
$\overline{0.0000}$	0.00 mA	$\overline{F 1}$ and $\overline{V 2}$ to adjust External Meter
$\overline{0.0040}$	4.00 mA	$\overline{F 1}$ and $\overline{V 2}$ to adjust External Meter
$\overline{0.0200}$	20.00 mA	$\overline{F 1}$ and $\overline{V 2}$ to adjust External Meter
$\overline{0.00}$	0.00 V	$\overline{F 1}$ and $\overline{V 2}$ to adjust External Meter
$\overline{10.00}$	10.00 V	$\overline{F 1}$ and $\overline{V 2}$ to adjust External Meter

3. Calibration Complete.

TROUBLESHOOTING

PROBLEM	REMEDIES
No Display At Power-Up	Check power level and power connections
No Display After Power-Up	Check Module 3: <i>d-LEU</i> , <i>d-Cont</i> , and <i>LINE 1</i> program settings.
Program Locked-Out	Check for Active User Input, programmed for <i>PLDC</i> . Deactivate User Input. Enter proper access code at <i>Code 0</i> prompt. (Universal access code = 222)
No Line 1 Display	Check Module 3: <i>LINE 1</i> program setting.
No Line 2 Display	Check Module 3: <i>RECESS</i> program settings.
No Programmable Units Display	Check Module 3: <i>UNIT5</i> Mnemonic program settings.
Incorrect Input Display Value	Check Input Jumper Setting, Input Level, and Input Connections. Verify Module 1 program settings. Contact factory
Display of <i>0L0L</i> , <i>ULUL</i> , <i>Short</i> , <i>OPEN</i> , or "..."	See General Meter Specifications, Display Messages.
Modules or Parameters Not Accessible	Check for corresponding option card. Verify parameter is valid in regard to previous program settings.
Error Code: <i>ErrKEY</i>	Keypad is active at power up. Check for depressed or stuck keypad. Press any key to clear Error Code.
Error Code: <i>EE PAr</i> Error Code: <i>EE Pdn</i>	Parameter Data Checksum Error. Press any key to clear Error Code, verify all program settings and cycle power. Contact factory if Error Code returns at next power-up.
Error Code: <i>ErrPra</i>	Parameter Data Validation Error. Press any key to clear Error Code, verify all program settings and cycle power. Contact factory if Error Code returns at next power-up.
Error Code: <i>EE CAL</i>	Calibration Data Validation Error. Contact factory.
Error Code: <i>EE Lin</i>	Linear Output Card Data Validation Error. Press any key to clear Error Code and cycle power. If Error Code returns at next power-up, replace Linear Option Card or contact factory.

PARAMETER VALUE CHART PAX2A

Programmer _____ Date _____
Unit# _____ Security Code _____

INPUT SETUP PARAMETERS

DISPLAY	PARAMETER	USER SETTING	DISPLAY	PARAMETER	USER SETTING
<i>rANGE</i>	INPUT RANGE	_____	<i>INPUT 7</i>	INPUT 7 SCALING VALUE	_____
<i>SCALE</i>	TEMPERATURE SCALE	_____	<i>diSPLy 7</i>	DISPLAY 7 VALUE	_____
<i>ICE</i>	ICE POINT COMPENSATION	_____	<i>INPUT 8</i>	INPUT 8 SCALING VALUE	_____
<i>rate</i>	ADC CONVERSION RATE	_____	<i>diSPLy 8</i>	DISPLAY 8 VALUE	_____
<i>decPt</i>	SCALING DECIMAL POINT	_____	<i>INPUT 9</i>	INPUT 9 SCALING VALUE	_____
<i>round</i>	DISPLAY ROUNDING	_____	<i>diSPLy 9</i>	DISPLAY 9 VALUE	_____
<i>offset</i>	DISPLAY OFFSET	_____	<i>INPUT 10</i>	INPUT 10 SCALING VALUE	_____
<i>filter</i>	DIGITAL FILTER	_____	<i>diSPLy 10</i>	DISPLAY 10 VALUE	_____
<i>band</i>	DIGITAL FILTER BAND	_____	<i>INPUT 11</i>	INPUT 11 SCALING VALUE	_____
<i>points</i>	SCALING POINTS	_____	<i>diSPLy 11</i>	DISPLAY 11 VALUE	_____
<i>style</i>	SCALING STYLE	_____	<i>INPUT 12</i>	INPUT 12 SCALING VALUE	_____
<i>input 1</i>	INPUT 1 SCALING VALUE	_____	<i>diSPLy 12</i>	DISPLAY 12 VALUE	_____
<i>diSPLy 1</i>	DISPLAY 1 VALUE	_____	<i>INPUT 13</i>	INPUT 13 SCALING VALUE	_____
<i>input 2</i>	INPUT 2 SCALING VALUE	_____	<i>diSPLy 13</i>	DISPLAY 13 VALUE	_____
<i>diSPLy 2</i>	DISPLAY 2 VALUE	_____	<i>INPUT 14</i>	INPUT 14 SCALING VALUE	_____
<i>input 3</i>	INPUT 3 SCALING VALUE	_____	<i>diSPLy 14</i>	DISPLAY 14 VALUE	_____
<i>diSPLy 3</i>	DISPLAY 3 VALUE	_____	<i>INPUT 15</i>	INPUT 15 SCALING VALUE	_____
<i>input 4</i>	INPUT 4 SCALING VALUE	_____	<i>diSPLy 15</i>	DISPLAY 15 VALUE	_____
<i>diSPLy 4</i>	DISPLAY 4 VALUE	_____	<i>INPUT 16</i>	INPUT 16 SCALING VALUE	_____
<i>input 5</i>	INPUT 5 SCALING VALUE	_____	<i>diSPLy 16</i>	DISPLAY 16 VALUE	_____
<i>diSPLy 5</i>	DISPLAY 5 VALUE	_____	<i>Scale</i>	ENABLE SCALE LIST	_____
<i>input 6</i>	INPUT 6 SCALING VALUE	_____			
<i>diSPLy 6</i>	DISPLAY 6 VALUE	_____			

2-FUNCT USER INPUT/FUNCTION KEY PARAMETERS

DISPLAY	PARAMETER	USER SETTING
USrAct	USER ACTIVE STATE	_____
USER-1	USER INPUT 1	_____
USER-2	USER INPUT 2	_____
F1	FUNCTION KEY 1	_____
F2	FUNCTION KEY 2	_____
SEC-F1	2nd FUNCTION KEY 1	_____
SEC-F2	2nd FUNCTION KEY 2	_____

4-SENdry SECONDARY FUNCTION PARAMETERS

DISPLAY	PARAMETER	USER SETTING
H-AS	MAX ASSIGNMENT	_____
H-t	MAX CAPTURE DELAY TIME	_____
LO-AS	MIN ASSIGNMENT	_____
LO-t	MIN CAPTURE DELAY TIME	_____
dSP-t	DISPLAY UPDATE TIME	_____

3-dISPLy DISPLAY PARAMETERS

DISPLAY	PARAMETER	USER SETTING
CoIor	LINE 1 DISPLAY COLOR	_____
d-LEU	DISPLAY LEVEL	_____
d-Cont	DISPLAY CONTRAST LEVEL	_____
LINE 1	LINE 1 DISPLAY	_____
UNtS	UNITS MNEMONIC	OFF LISt
UNtS1	SEGMENT 1	_____
UNtS2	SEGMENT 2	_____
UNtS3	SEGMENT 3	_____
ACCESs	LINE 2 LOOP ACCESSIBLE ITEMS	NO YES
INPUt	_____	b2-d2 _____
totAL	_____	53 _____
Hi	_____	b3-d3 _____
Lo	_____	54 _____
LISt	_____	b4-d4 _____
51	_____	CoIor _____
b1-d1	_____	d-LEU _____
52	_____	d-Cont _____
FUNCT	LINE 2 USER FUNC. ACCESS. ITEMS	NO YES
rEL	_____	r-2 _____
bALt	_____	r-3 _____
r-tot	_____	r-4 _____
r-H	_____	r-34 _____
r-Lo	_____	r-234 _____
r-HL	_____	r-ALL _____
r-1	_____	Prnt _____
CoDE	SECURITY CODE	_____

5-totAL TOTALIZER PARAMETERS

DISPLAY	PARAMETER	USER SETTING
dECPtE	TOTALIZER DECIMAL POINT	_____
t bASE	TOTALIZER TIME BASE	_____
ScLFAC	TOTALIZER SCALE FACTOR	_____
Lo Cut	TOTALIZER LOW CUT VALUE	_____
PwrUP	TOTALIZER POWER-UP RESET	_____

7-SerIAL SERIAL COMMUNICATIONS PARAMETERS

DISPLAY	PARAMETER	USER SETTING
USb	USB PORT	_____
tYPE	TYPE	_____
bAUD	BAUD RATE	_____
dALtA	WORD LENGTH	_____
PARitY	PARITY	_____
Addr	UNIT ADDRESS	_____
dELAY	TRANSMIT DELAY	_____
Abbrv	ABBREVIATED	_____
OPt	PRINT OPTION	NO YES
INPUt	Signal Input	_____
totAL	Total Value	_____
HI LO	Max & Min	_____
SPtE	Setpoint Values	_____

8-AnLOut ANALOG OUTPUT PARAMETERS

DISPLAY	PARAMETER	USER SETTING
tYPE	ANALOG TYPE	_____
ASSIGN	ANALOG ASSIGNMENT	_____
ANALOG ^{LO}	ANALOG LOW	_____
ANALOG ^{HI}	ANALOG HIGH	_____
UPdATE	ANALOG UPDATE TIME	_____
brnAct	PROBE BURN-OUT ACTION	_____

6-SEtPtE SETPOINT OUTPUT PARAMETERS

DISPLAY	PARAMETER	USER SETTING	USER SETTING	USER SETTING	USER SETTING
		S1	S2	S3	S4
SELEct	SETPOINT SELECTION	_____	_____	_____	_____
ASSIGN	SETPOINT SOURCE	_____	_____	_____	_____
ActiON	ACTION FOR SETPOINT	_____	_____	_____	_____
SEtPtE	SETPOINT VALUE	_____	_____	_____	_____
bn-dEU	SETPOINT BAND/DEVIATION VALUE	_____	_____	_____	_____
HYStEr	HYSTERESIS FOR SETPOINT	_____	_____	_____	_____
t-ON	ON TIME DELAY SETPOINT	_____	_____	_____	_____
t-OFF	OFF TIME DELAY SETPOINT	_____	_____	_____	_____
LOGiC	OUTPUT LOGIC	_____	_____	_____	_____
rESEt	RESET ACTION	_____	_____	_____	_____
Stndby	STANDBY OPERATION	_____	_____	_____	_____
Annun	OUTPUT ANNUNCIATOR LIGHT	_____	_____	_____	_____
CoIor	CHANGE COLOR	_____	_____	_____	_____
brnAct	PROBE BURN-OUT ACTION	_____	_____	_____	_____

PAX2A PROGRAMMING QUICK OVERVIEW

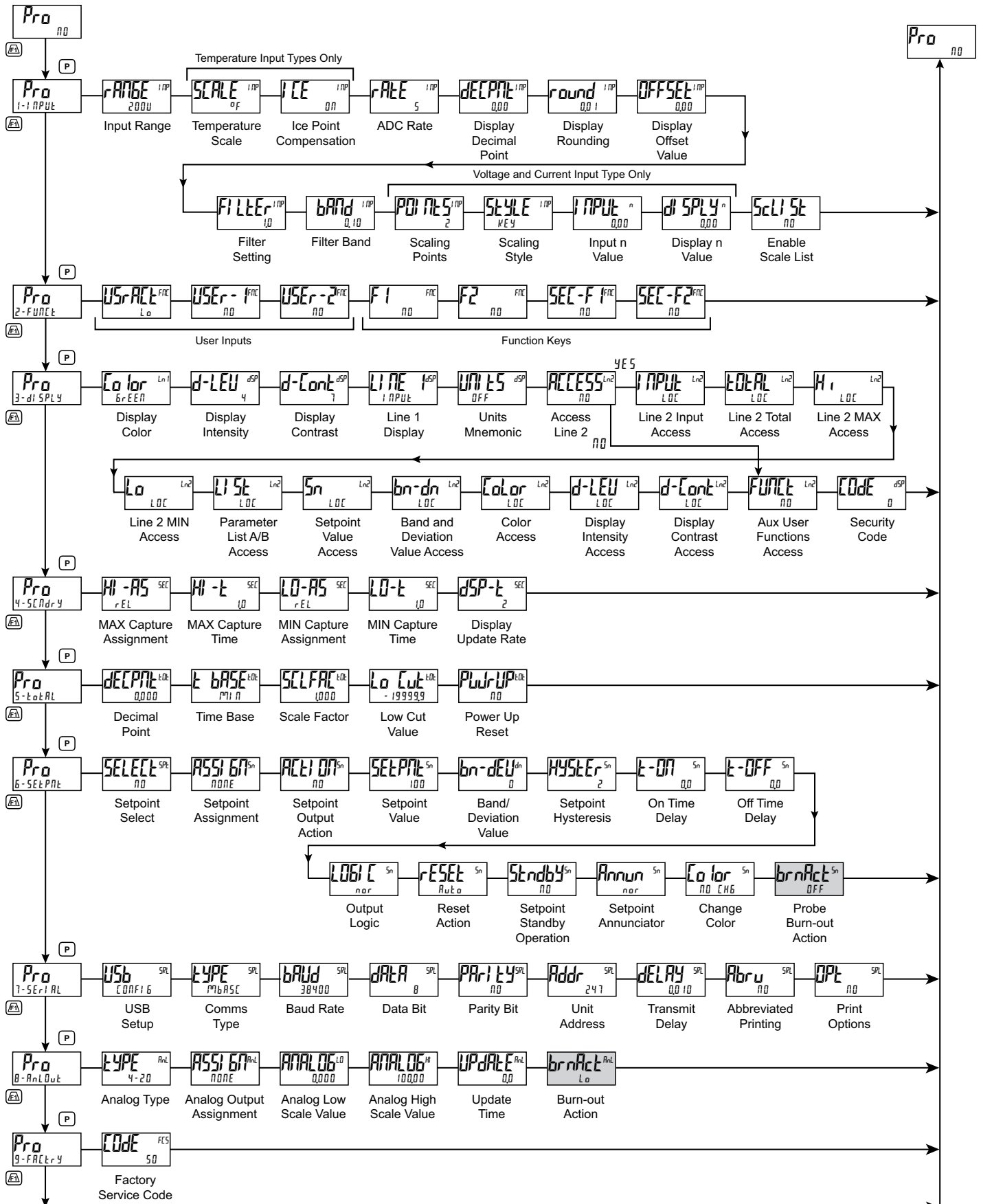

LIMITED WARRANTY

(a) Red Lion Controls Inc., Sixnet Inc., N-Tron Corporation, or Blue Tree Wireless Data, Inc. (the "Company") warrants that all Products shall be free from defects in material and workmanship under normal use for the period of time provided in "Statement of Warranty Periods" (available at www.redlion.net) current at the time of shipment of the Products (the "Warranty Period"). **EXCEPT FOR THE ABOVE-STATED WARRANTY, COMPANY MAKES NO WARRANTY WHATSOEVER WITH RESPECT TO THE PRODUCTS, INCLUDING ANY (A) WARRANTY OF MERCHANTABILITY; (B) WARRANTY OF FITNESS FOR A PARTICULAR PURPOSE; OR (C) WARRANTY AGAINST INFRINGEMENT OF INTELLECTUAL PROPERTY RIGHTS OF A THIRD PARTY; WHETHER EXPRESS OR IMPLIED BY LAW, COURSE OF DEALING, COURSE OF PERFORMANCE, USAGE OF TRADE OR OTHERWISE.** Customer shall be responsible for determining that a Product is suitable for Customer's use and that such use complies with any applicable local, state or federal law.

(b) The Company shall not be liable for a breach of the warranty set forth in paragraph (a) if (i) the defect is a result of Customer's failure to store, install, commission or maintain the Product according to specifications; (ii) Customer alters or repairs such Product without the prior written consent of Company.

(c) Subject to paragraph (b), with respect to any such Product during the Warranty Period, Company shall, in its sole discretion, either (i) repair or replace the Product; or (ii) credit or refund the price of Product provided that, if Company so requests, Customer shall, at Company's expense, return such Product to Company.

(d) **THE REMEDIES SET FORTH IN PARAGRAPH (c) SHALL BE THE CUSTOMER'S SOLE AND EXCLUSIVE REMEDY AND COMPANY'S ENTIRE LIABILITY FOR ANY BREACH OF THE LIMITED WARRANTY SET FORTH IN PARAGRAPH (a).**

Red Lion Controls
Headquarters
20 Willow Springs Circle
York PA 17406
Tel +1 (717) 767-6511
Fax +1 (717) 764-0839

Red Lion Controls
Europe
Softwareweg 9
NL - 3821 BN Amersfoort
Tel +31 (0) 334 723 225
Fax +31 (0) 334 893 793

Red Lion Controls
India
201-B, 2nd Floor, Park Centra
Opp 32 Mile Stone, Sector-30
Gurgaon-122002 Haryana, India
Tel +91 984 487 0503

Red Lion Controls
China
Unit 1102, XinMao Plaza
Building 9, No.99 Tianzhou Road
ShangHai, P.R. China 200223
Tel +86 21 6113 3688
Fax +86 21 6113 3683